

CREST 2819 "HUNTER MARINE STYLE" SLOTTED TOE RAIL

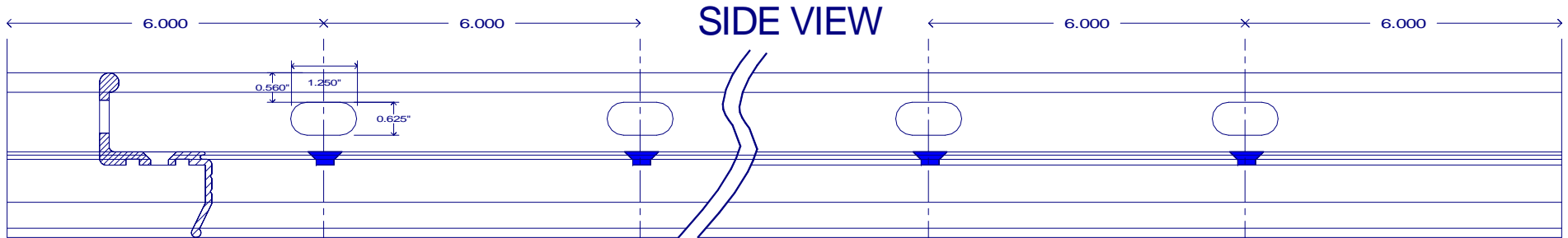

MARINE PRODUCTS
www.crestaluminum.com

Crest Aluminum Products Inc
Part No. 2819CL-31
Die No. CTP-51
Hunter Slotted Toe Rail



SIDE VIEW

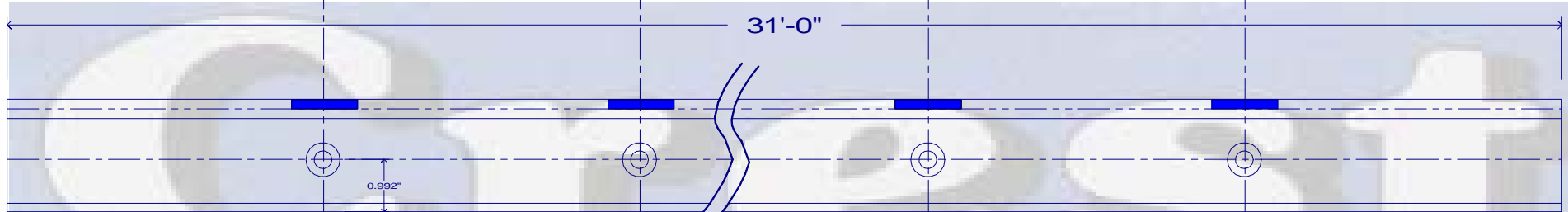

TOP VIEW

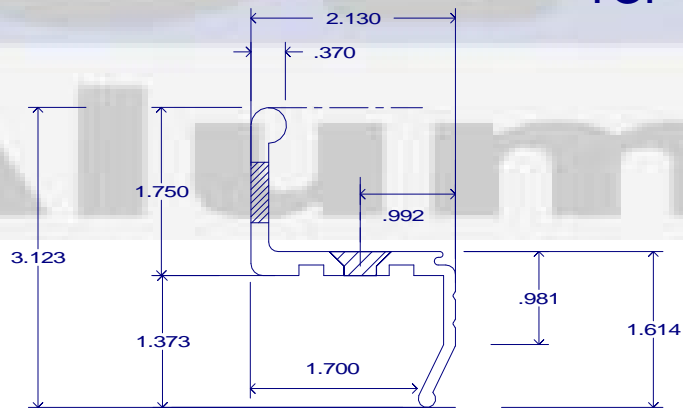

SECTION VIEW

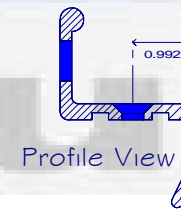

Profile View

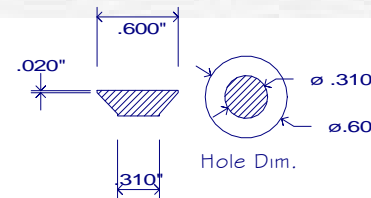

Hole Dim.

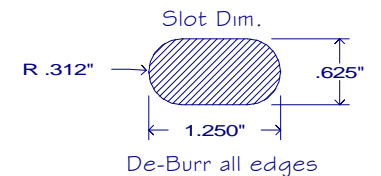

De-Burr all edges

Notes:

- Alloy:** 6061 T-6
- Finish:** Hard Coat Anod.
30 Min Clr. Velo
- Lengths:** 31' - 0"
- Slots:** 6" On Center
- Holes:** 6" On Center
- Wt./ Ft.:** 1.132 lbs.

PART NO	C-2819-CL		Crest Aluminum Products Inc 8287 Tyler Blvd Mentor OH 44060 USA	REVISIONS	DATE
ALLOY	6061 T-6				
FINISH	30 MIN CLR VELO	JOB NO.	DATE: 04-10-07		
LENGTHS	31'-0"	CUSTOMER / PROJECT			
UNSPEC RADIUS	.016"	"HUNTER MARINE" Style Toe Rail			
DRAWING BY:	J. M. ALLIN	© Crest Aluminum Products Inc 2007 J.M. Allin			