

ASSEMBLY INSTRUCTIONS

Suburb-A-Port

G Hanging Rail Patio Cover

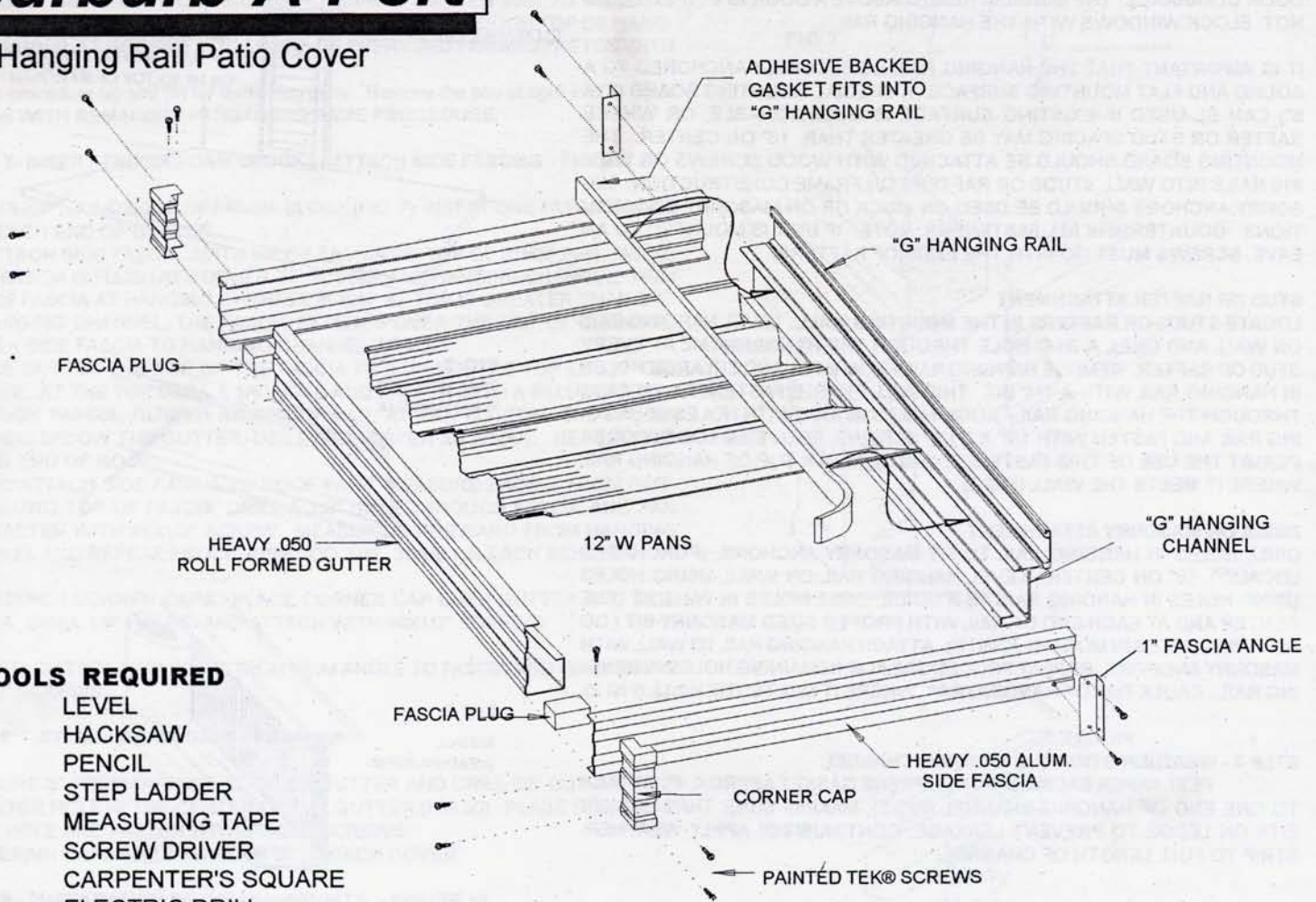

TOOLS REQUIRED

- LEVEL
- HACKSAW
- PENCIL
- STEP LADDER
- MEASURING TAPE
- SCREW DRIVER
- CARPENTER'S SQUARE
- ELECTRIC DRILL
- 1/4" DRIVER OR SOCKET WRENCH
- DRILL BITS: 1/8", 3/16", 5/16", & (7/16" MASONRY if needed)

OPTIONAL ITEMS

- MOUNTING POSTS AND BEAM (SOLD SEPARATELY)**
- OPTIONAL 2x6 MOUNTING BOARD AND WOOD SCREWS OR #16 NAILS
- MASONRY ANCHORS AND SCREWS (FOR CONCRETE PATIO BASES)

WEAR SAFETY GOGGLES
WHEN DRILLING OR
CUTTING METAL

Introduction:

Your new **Suburb-A-Port** patio cover will arrive in 3 cartons. The roof panels will be packaged in 2 cartons. The gutter, side fascias and hardware items will be packed in 1 long carton. The best way to start is to remove all parts and lay out in work area and examine them. The roof pans have a top and a bottom. The top has a bead and the panels will interlock together to form a structural roof system.

Suburb-A-Port Kit Components

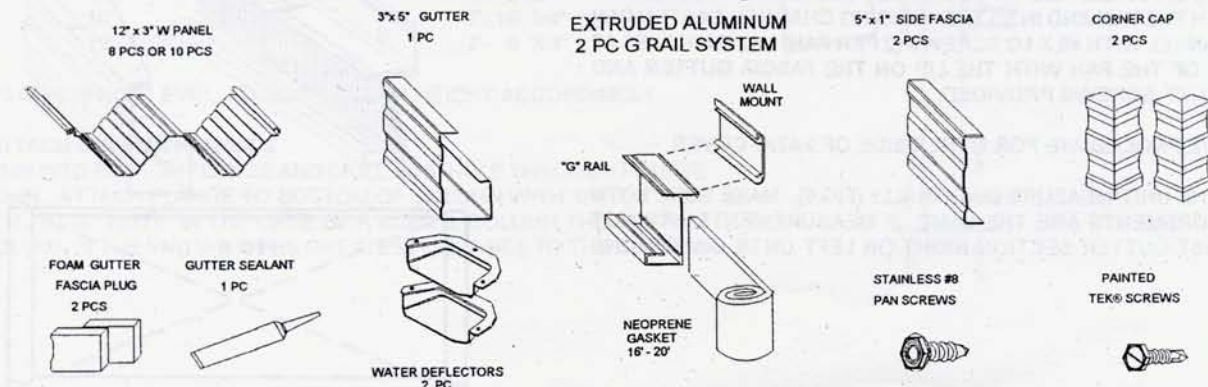

STEP 1- ATTACH HANGING RAIL TO WALL

THE HEIGHT FROM THE GROUND TO THE BOTTOM OF THE HANGING RAIL IS 8'- 3 7/8". FOR MOST INSTALLATIONS OVER A DOOR, IN ORDER TO MAINTAIN DOOR CLEARANCE, THE MINIMUM HEIGHT ABOVE A DOOR IS 6". (FIG. 1). DO NOT BLOCK WINDOWS WITH THE HANGING RAIL.

IT IS IMPORTANT THAT THE HANGING RAIL BE SECURELY ANCHORED TO A SOUND AND FLAT MOUNTING SURFACE. A SPECIAL MOUNTING BOARD (2" X 6") CAN BE USED IF EXISTING SURFACE IS QUESTIONABLE, OR WHERE RAFTER OR STUD SPACING MAY BE GREATER THAN 16" ON CENTER. THE MOUNTING BOARD SHOULD BE ATTACHED WITH WOOD SCREWS OR WITH #16 NAILS INTO WALL STUDS OR RAFTERS ON FRAME CONSTRUCTION. MASONRY ANCHORS SHOULD BE USED ON BRICK OR ON MASONRY INSTALLATIONS. COUNTERSINK ALL FASTENERS. NOTE: IF UNIT IS MOUNTED TO AN EAVE, SCREWS MUST GO INTO THE ENDS OF RAFTERS.

STUD OR RAFTER ATTACHMENT

LOCATE STUDS OR RAFTERS IN THE MOUNTING WALL. LEVEL HANGING RAIL ON WALL AND DRILL A 3/16" HOLE THROUGH THE HANGING RAIL AT EVERY STUD OR RAFTER. REMOVE HANGING RAIL FROM WALL AND ENLARGE HOLES IN HANGING RAIL WITH A 1/4" BIT. THIS WILL ENABLE FASTENERS TO PASS THROUGH THE HANGING RAIL. ALIGN HOLES IN RAIL WITH HOLES IN HANGING RAIL AND FASTEN WITH 1/4" X 2 1/2" SCREWS, PROVIDED LOCAL CODES PERMIT THE USE OF THIS FASTENER. (FIG 2). CAULK TOP OF HANGING RAIL WHERE IT MEETS THE WALL (FIG 2).

BRICK OR MASONRY ATTACHMENT

DRILL HOLES IN HANGING RAIL TO FIT MASONRY ANCHORS. (PURCHASED LOCALLY), 16" ON CENTER. LEVEL HANGING RAIL ON WALL, USING HOLES USING HOLES IN HANGING RAIL AS A GUIDE, DRILL HOLES IN WALL AT THE CENTER AND AT EACH END OF RAIL WITH PROPER SIZED MASONRY BIT (DO NOT DRILL HOLES IN MORTAR JOINTS). ATTACH HANGING RAIL TO WALL WITH MASONRY ANCHORS. REPEAT PROCEDURE FOR REMAINING HOLES IN HANGING RAIL. CAULK TOP OF HANGING RAIL WHERE IT MEETS THE WALL (FIG 2).

FIGURE 3

STEP 3 - WEATHER-STRIP THE HANGING CHANNEL

PEEL PAPER BACKING ON NEOPRENE GASKET APPROX. 4". ATTACH TO ONE END OF HANGING CHANNEL (FIG 5), MAKING SURE THAT GASKET SITS ON LEDGE TO PREVENT LEAKAGE. CONTINUE TO APPLY WEATHER-STRIP TO FULL LENGTH OF CHANNEL.

STEP 4 - PLACE HANGING CHANNEL INTO HANGING RAIL

FIGURE 4
SET HANGING CHANNEL INTO GROOVE ON BOTTOM OF HANGING RAIL. TILT HANGING CHANNEL UPWARD AND TOWARD THE WALL. HANGING CHANNEL WILL SLIP INTO RAIL SLOT. LET HANGING CHANNEL DOWN IN PLACE. FIG 6. NOTE: IF WALL IS UNEVEN, YOU MAY NEED TO LOOSEN FASTENERS ON HANGING RAIL TO SEAT CHANNEL INTO RAIL. TIGHTEN ALL SCREWS IN RAIL AFTER CHANNEL IS SEATED.

STEP 5 - BEGIN W PAN INSTALLATION & SQUARE COVER

FIGURE 5
(A) SET THE FRONT GUTTER ON SAW HORSES. DRAW LINES ON TOP OF GUTTER AT 12" INTERVALS. DO THE SAME AT THE HANGING CHANNEL.

(B) ONE END OF THE ROOF PAN HAS 2 HOLES, THIS IS THE FRONT OR GUTTER END. MAKING SURE PAN IS BUTTED TIGHT AGAINST WEATHER-STRIPPING ON HANGING CHANNEL, AND FITS BETWEEN THE 12" MARKS, DRILL A 1/8" HOLE THROUGH THE PAN AND INTO THE HANGING CHANNEL. FASTEN PAN TO HANGING CHANNEL WITH #8 X 1/2 SCREWS (2 PER PAN). ALIGN HOLES AT THE FRONT END OF THE PAN WITH THE LIP ON THE FASCIA GUTTER AND ATTACH WITH #8X1/2" SCREWS PROVIDED.

(C) REPEAT ABOVE PROCEDURE FOR OTHER SIDE OF PATIO COVER.

(D) TO SQUARE THE UNIT, MEASURE DIAGONALLY (FIG 6). MAKE SURE BOTH DIAGONAL MEASUREMENTS ARE THE SAME. IF MEASUREMENTS ARE NOT THE SAME, ADJUST GUTTER SECTION RIGHT OR LEFT UNTIL DIMENSIONS ARE EQUAL.

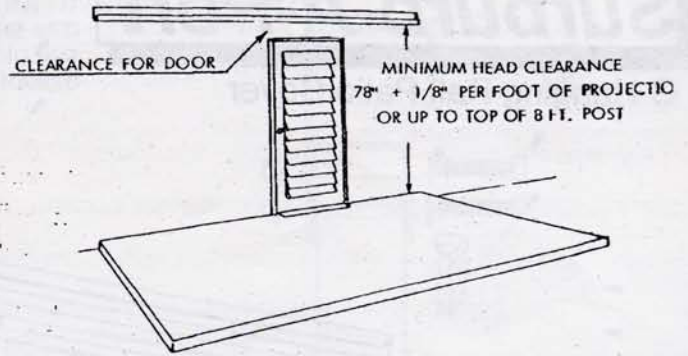

FIG 2
DRILL 3/16" HOLES
IN HANGING RAIL

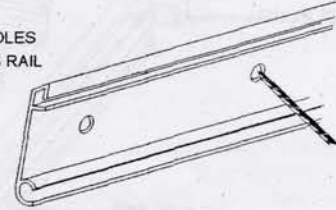

FIG 3
INSTALL
WEATHER-STRIP

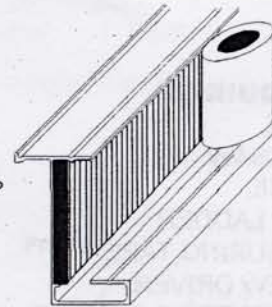
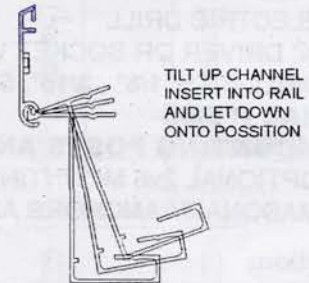
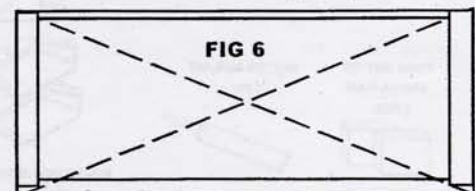
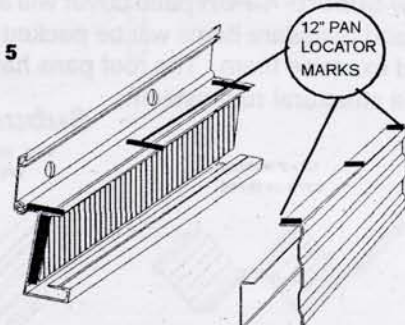

FIG 4



TILT UP CHANNEL
INSERT INTO RAIL
AND LET DOWN
ONTO POSITION

FIG 5



STEP 6 - ATTACH BALANCE OF ROOF PANS

(A) ROOF PANS WILL BE ATTACHED FROM LEFT TO RIGHT. PANS ARE DESIGNED TO EITHER ROLL-LOCK OR SLIDE INTO PLACE.

(B) WITH END OF PAN FIRMLY AGAINST WEATHER STRIPPING, DRILL 1/8" HOLES THROUGH PAN AND INTO HANGING CHANNEL. FASTEN PAN TO HANGING CHANNEL WITH #8X1/2" SCREWS. DRILL A 1/8" HOLE THROUGH TOP OF HANGING CHANNEL AT GROOVE INTO LOCKS OF EVERY 3RD PAN AND FASTEN WITH #8X1/2" SCREW.

Repeat procedure (a) and (b) for remaining pans. Remove the pan at right end of cover and lock WITH REMAINING PANS USING SAME PROCEDURE.

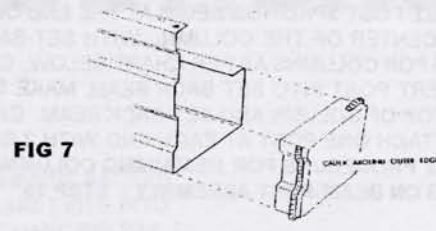

FIG 7

STEP 7 - INSERT FASCIA FOAM BLOCKS- ATTACH SIDE FASCIAS - FIGURE 8

(A) CAULK AROUND EDGE OF FASCIA BLOCK (FIG. 7) INSERT ONE FASCIA BLOCK INTO EACH END OF GUTTER.

(B) ATTACH SIDE FASCIA. WITH LIP OF FASCIA ON TOP OF ROOF PAN, MAKE SURE FASCIA IS FLUSH AT CORNER OF GUTTER AND HANGING CHANNEL. TRIM END OF FASCIA AT HANGING CHANNEL IF GAP AT TOP IS GREATER THAN 3/4". AT HANGING CHANNEL, THE FASCIA EXTENDS OVER THE TOP OF CHANNEL. FASTEN SIDE FASCIA TO HANGING CHANNEL AT TOP.

AT THE GUTTER THE TOP OF THE FASCIA FITS UNDER THE TOP LIP OF THE GUTTER. AT THE TOP DRILL A 1/8" HOLE AND FASTEN WITH A #8X1/2" SCREW THROUGH FASCIA, GUTTER AND ROOF PAN. AT THE BOTTOM, THE FASCIA EXTENDS BELOW THE GUTTER. DRILL AND FASTEN AS ABOVE. REPEAT FOR OTHER END OF ROOF.

TO ATTACH SIDE FASCIA TO ROOF PANS, MEASURE BACK 3' FROM GUTTER ALONG TOP OF FASCIA, DRILL A 1/8" HOLE THROUGH FASCIA AND PAN AND FASTEN WITH #8X1/2" SCREW. MEASURE 3' FORWARD FROM HANGING CHANNEL AND REPEAT PROCEDURE. DO THE SAME ON EACH SIDE.

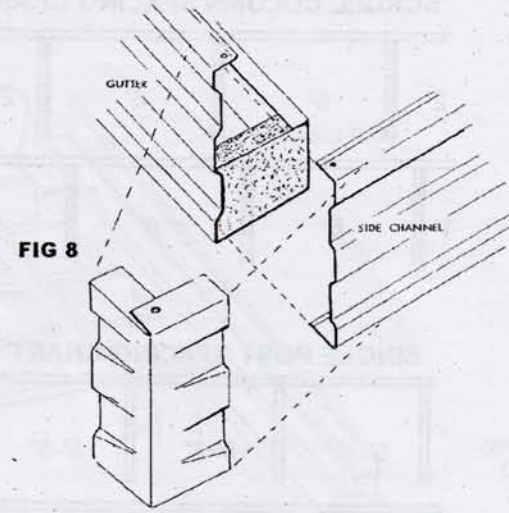

FIG 8

CORNER ATTACHES OVER SIDE AND GUTTER

(C) ATTACH CORNER CAPS. PLACE CORNER CAP OVER GUTTER AND SIDE FASCIA. DRILL 1/8" HOLES AND ATTACH WITH #8X1/2" SCREWS.

(D) ATTACH TRIM ANGLES. ATTACH TRIM ANGLE TO FASCIA AND WALL USING #8X1/2" SCREWS.

STEP 8 - ATTACH DRAIN CAPS - FIGURE 9

MEASURE 5" FROM OUTSIDE EDGE OF GUTTER AND DRILL OR CUT AN 1 1/2" DIAMETER HOLE IN THE CENTER OF THE GUTTER (FIG 50). PLACE DRAIN CAP OVER HOLE AND FASTEN WITH #8X1/2" SCREWS. TWO DRAIN CAPS ARE PROVIDED WITH EACH COVER.

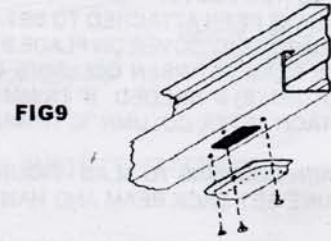

FIG 9

STEP 9 - PREPARATION OF COLUMNS/POSTS - FIGURE 10

EACH UNIT WILL REQUIRE 3 OR MORE COLUMNS/POSTS. COMPLETED PATIO COVER MUST BE LOWER IN FRONT THAN AT REAR TO ALLOW FOR PROPER WATER DRAINAGE.

NOTE: YOU NEED A MINIMUM OF 1/4" OF SLOPE PER FOOT OF PROJECTION. CUT THE COLUMNS (IF NEEDED), TO HEIGHT FOR THE SLOPE DESIRED. IF YOUR HANGING RAIL IS 8' 3 7/8" ABOVE THE GROUND, LOCATE THE PROJECTION OF YOUR COVER ON THE CHART BELOW. CUT COLUMNS (MAKE CUTS FROM SAME END OF ALL COLUMNS) TO HEIGHT REQUIRED FOR PROPER SLOPE.

NOTE: DIMENSIONS BELOW, ONLY APPLY IF THE HANGING RAIL IS 8' 3 7/8" ABOVE GROUND OR SLAB AND THE GROUND OR SLAB IS LEVEL. IF DOORS OR WINDOWS OPEN OUT UNDER THE PATIO COVER, COLUMN HEIGHT MAY BE GREATER.

PROJECTION	HEIGHT OF COLUMN AFTER CUTTING
8'	7'- 10 3/4"
10'	7'- 10 1/4"
12'	7'- 9 3/4"

NOTE: IF FLOOR IS NOT LEVEL, ADJUST COLUMN HEIGHT ACCORDINGLY.

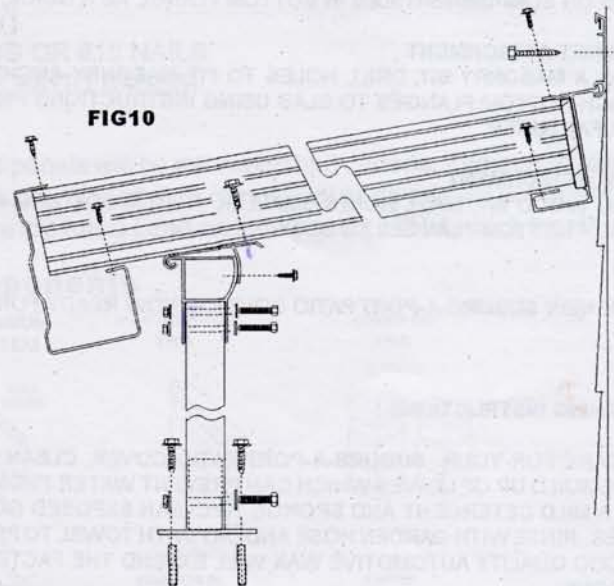

FIG 10

STEP 10 ATTACH COLUMN FLANGES

SET COLUMN INTO BOTTOM FLANGE AND DRILL 5/16" HOLE THROUGH FLANGE AND COLUMN. ATTACH FLANGE TO BOTTOM OF COLUMN WITH 1/4" X 2" NUT AND BOLT (FIG 9) NOTE: IN THE CASE OF A SCROLL COLUMN THE BOTTOM OF THE COLUMN IS THE END WITH THE GREATEST DISTANCE TO THE SCROLL.

STEP 11 ATTACH COLUMNS TO SET BACK BEAM - FIGURE 11

SEE COLUMN SPACING CHART BELOW TO DETERMINE COLUMN SPACING FOR YOUR PATIO COVER. ALL POST SPACINGS BEGIN AT THE END OF THE COVER AND ARE MEASURED TO THE CENTER OF THE COLUMN. WITH SET-BACK BEAM ON THE GROUND, MARK SPACINGS FOR COLUMNS AS PER CHART BELOW. CENTER COLUMNS ON THESE SPACINGS. INSERT POST INTO SET BACK BEAM. MAKE SURE THERE IS A FLUSH FIT BETWEEN THE TOP OF COLUMN AND SET-BACK BEAM. DRILL A 5/16" HOLE IN THE SET-BACK BEAM. ATTACH ONE POST AT EACH END WITH 2 EACH 1/4" X 2" BOLT AND NUT (FIG 11). REPEAT PROCEDURE FOR REMAINING COLUMN(S) AFTER COVER IS RAISED UP AND RESTING ON BEAM-POST ASSEMBLY - STEP 12.

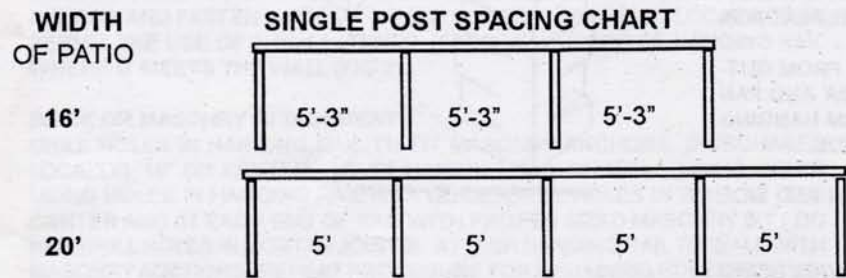
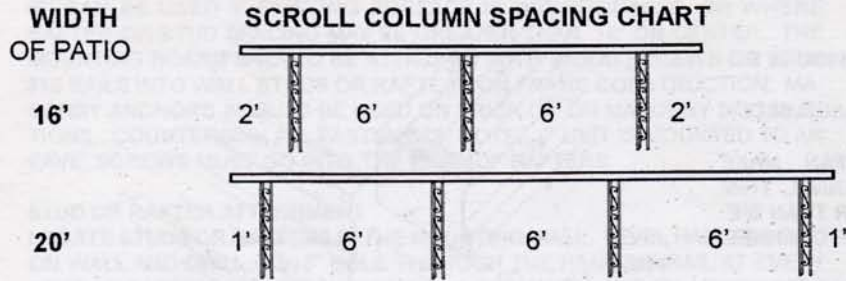
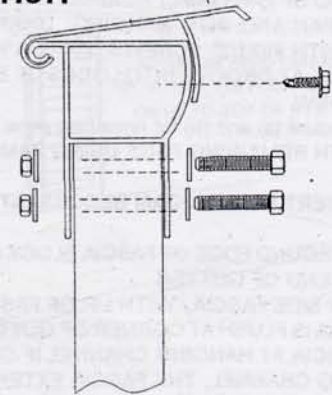

FIG11



STEP 12 - RAISE COVER AND SET ON POSTS

AFTER THE 2 END COLUMNS HAVE BEEN ATTACHED TO SET BACK BEAM, RAISE FRONT OF ASSEMBLED PATIO COVER AND REST COVER ON PLACE BEAM SECTION AND POSTS. PLACE A LEVEL ON SET BACK BEAM BETWEEN COLUMNS. CHECK TO SEE IF BEAM IS LEVEL. TRIM BOTTOM OF COLUMN(S) IF NEEDED. IF TRIMMING IS REQUIRED REMOVE BOTTOM FLANGE AND REATTACH AFTER COLUMN IS TRIMMED.

STEP 13 - LEVEL AND ATTACH COLUMNS TO SLAB - FIGURE 12

(A) CHECK TO MAKE SURE SET BACK BEAM AND HANGING CHANNEL ARE STILL SQUARE.

(B) PLUMB EACH COLUMN. STAND AT ONE END AND VISUALLY CHECK ALIGNMENT OF COLUMNS. ONCE ALL COLUMNS ARE PLUMB AND ALIGNED, MARK FASTENER LOCATIONS ON SLAB USING HOLES IN BOTTOM FLANGE AS A GUIDE.

MASONRY ATTACHMENT

USING A MASONRY BIT, DRILL HOLES TO FIT MASONRY ANCHORS (NOT PROVIDED). ATTACH BOTTOM FLANGES TO SLAB USING INSTRUCTIONS PROVIDED BY FASTENER MANUFACTURER.

DECK ATTACHMENT

USING WOOD BIT, DRILL HOLES SMALLER THAN WOOD ANCHORS (NOT PROVIDED). ATTACH BOTTOM FLANGES TO DECK.

FIG12

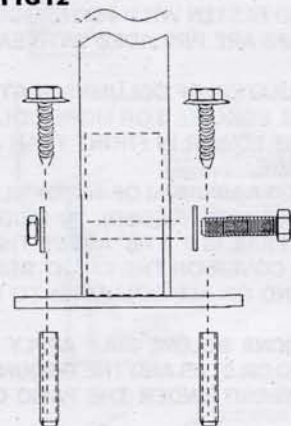

YOUR NEW **SUBURB-A-PORT** PATIO COVER IS NOW READY FOR USE !!!

CLEANING INSTRUCTIONS

TO CARE FOR YOUR **SUBURB-A-PORT** PATIO COVER, CLEAN OUT GUTTERS TO REMOVE BUILD UP OF LEAVES WHICH CAN PREVENT WATER FROM DRAINING PROPERLY. USE A MILD DETERGENT AND SPONGE TO CLEAN EXPOSED GUTTER AND ROOF SURFACES. RINSE WITH GARDEN HOSE AND DRY WITH TOWEL TO PREVENT WATER SPOTS. A GOOD QUALITY AUTOMOTIVE WAX WILL EXTEND THE FACTORY FINISH FOR YEARS TO COME.