

2" NatureScape[®] Sunroom Extrusions

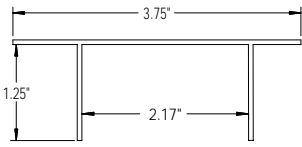

7715
2" Flat Top Cap

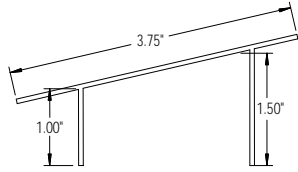

7751
2" Sloped Top Cap

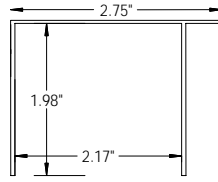

7718
2" F Top Cap

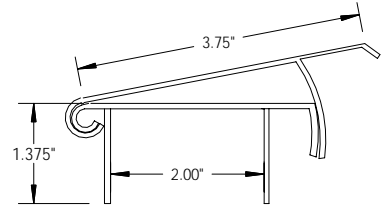

7715A
2" Adjustable Top Cap

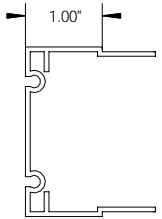

77103
2" Male Column Channel

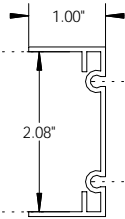

77104
2" Female Column Channel

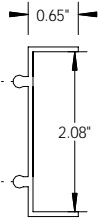

77105
2" Panel Adapter

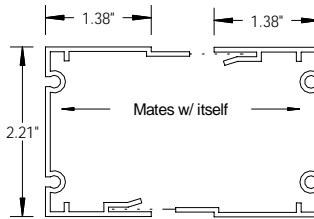

77102
2" Self-Mating Column Channel

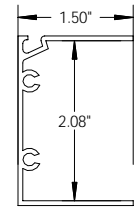

77122
2" Screen Channel

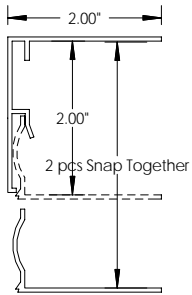

7717
2" 2 pc In-Fill Channel

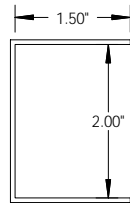

7716
2" Receiving Channel

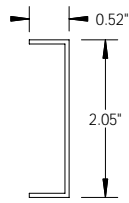

7716A
2" D.R.C. Channel

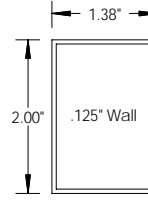

77107
2" Extruded Column Insert

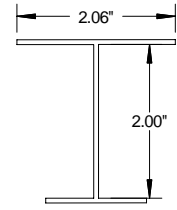

44616
2" H Channel

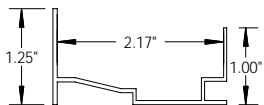

7713
2" Sloped Base Channel

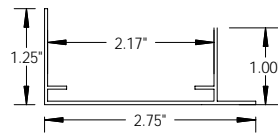

7712
2" F Base Channel

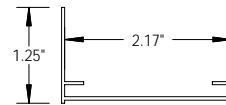

7714
2" Regular Base Channel

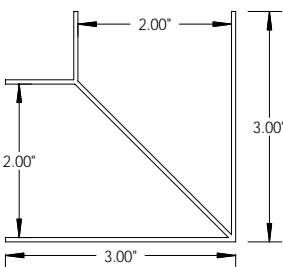

7719
2" Corner Channel

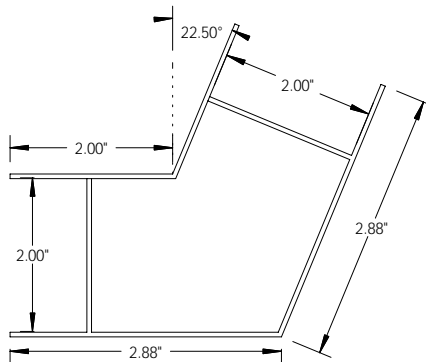

7719A
2" 22.5° Corner Channel

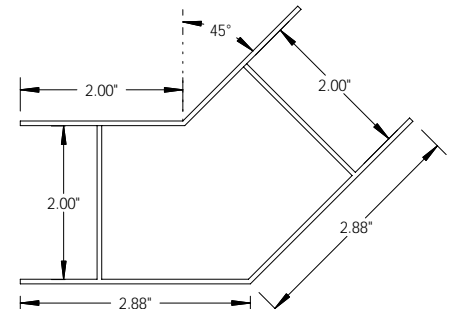

7719B
2" 45° Corner Channel

3" NatureScape® Sunroom Extrusions

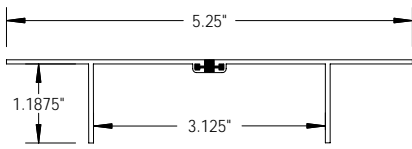

7902
3" Flat Top Cap

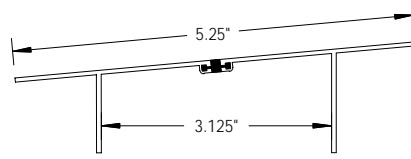

7902A
3" Sloped Top Cap

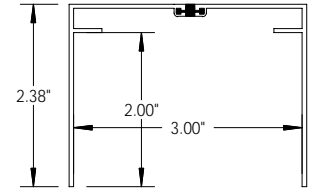

7912
3" Deep Top Cap

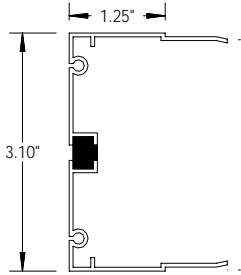

7913
3" Male Column Channel

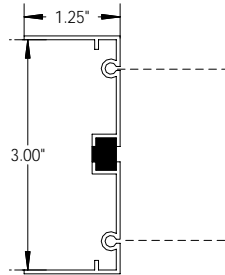

7909
3" Female Column Channel

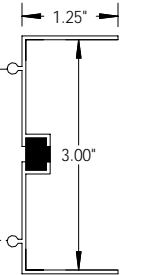

7910
3" Panel Adapter

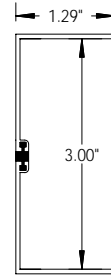

7904
3" Receiving Channel

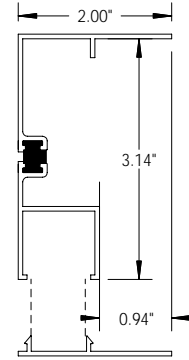

7901-B
3" 2 pc Channel w/ Snap

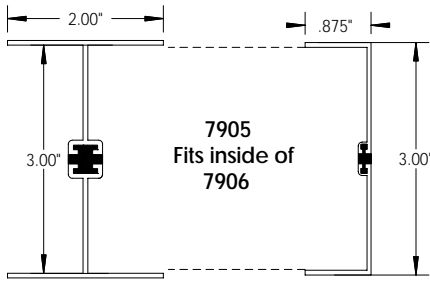

7903
3" H Channel

7905
3" D.R.C. Channel

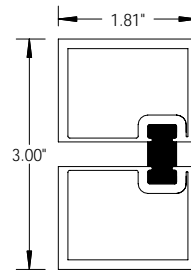

79106
3" Extruded Column Insert

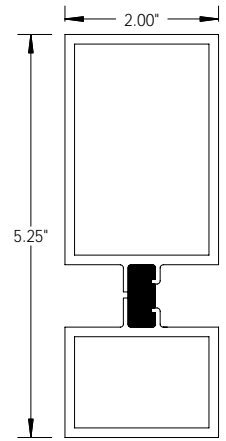

7911
SGD Framing Tube

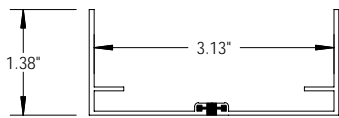

7901
3" Base Channel

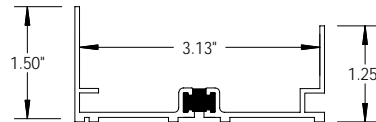

7901-A
3" Base Channel w/ Weep

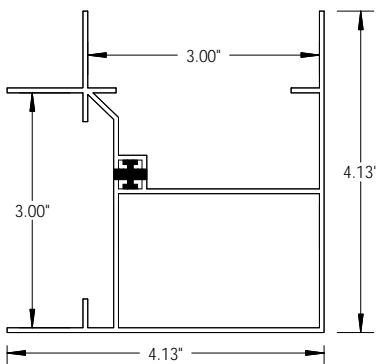

7906
3" Corner Channel

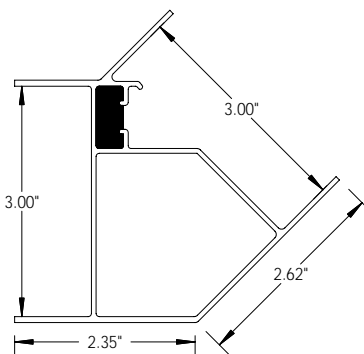

7906A
3" 45° Corner Channel

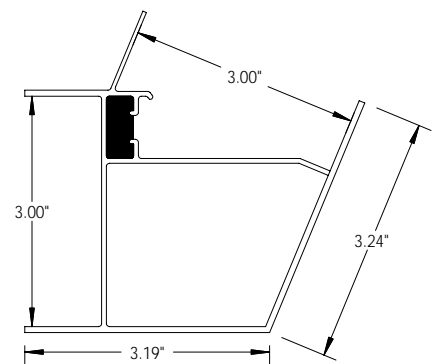

7906B
3" 22.5° Corner Channel