

THE NEW LEADER IN  
ALUMINUM BUILDING  
PRODUCTS



2023

ALUMINUM BUILDING PRODUCTS

- Stepdown Awning Components
- Patio, Deck & Walkway Cover Components
- Posts, Columns & Structural Beams
- Screen Enclosure Components
- Insulated Roof & Room Components
- Fasteners, Sealants & Accessories
- Sovereign Aluminum Railing Kits
- Comfort-Tite Storm Doors



## Thank you for allowing Crest Aluminum to be your supplier...

And thank you for taking the time to look over our 2023/2024 Catalog.

During the Post-Covid turmoil the past two years with supply shortages, insane lead times, and demand for our product from all over the country, we are proud to say we put You - our existing customer - first and turned down business so we could provide for those who have depended upon us and helped build this company.

There were many times we could have emptied the building with inquiries from companies willing to pay anything for product and whose suppliers had thrown them under the bus because they had taken orders from the big box stores and those who lost their off-shore suppliers.

We are blessed to be one of the few remaining privately held, Family-Owned and Operated Manufacturers of Aluminum Building products in the United States. We remain focused on the step-down awning, patio/deck cover and screen room trade with an ever-expanding product offering that now encompasses light commercial dock and walkway covers, insulated roof and room systems, and our screen and storm door product line. We supply Aluminum Coil to a vast array of fabricators and now offer leveled and cut-to-length sheet for the Sign and Truck-Trailer markets. We also just recently introduced Black in the entire Cover and Screen Room Lines.

I promise that one thing will never change...When you call us, you will talk to a real person. "No Voice Mail, Just Real People" is more than a slogan, it's the way we do business. We are blessed with a wonderful company over here. We know that it wouldn't be possible without customers like you, great employees and our vendors, for that we are eternally thankful.

As always, thanks for calling and may God Bless America.

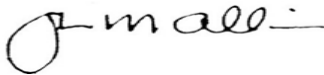









John Allin Sr.  
Co-Founder, President and CEO  
Crest Aluminum Products Inc



We are a small company offering you over 244 years of continuous employee knowledge and service.

John Allin Sr.	President-CEO - 51 years
Pete Antos	Vice President-Treasurer - 45 years
Mark Murray	Manufacturing and Operations Manager - 40 years
Dave Harton	Manufacturing Roll Form Division - 30 years
Eric Wassum	Slitting Division and Plant Operations Manager - 26 years
John Allin Jr.	Vice President of Sales-General Manager - 19 years
Brett Wassum	NatureScape and Door Division - 17 years
Jarret Nagy	Shipping and Receiving Manager - 6 years
Paul Mora	Company Driver - 5 years
Sam Krejci	Manufacturing - 3 years
Dan Quick	Inside Sales - Office and Customer Service Manager - 2 years

# Contents

	Stepdown Awning Components	<b>04</b>
	Patio, Deck, & Walkway Cover Components	<b>18</b>
	Posts, Columns, & Structural Beams	<b>50</b>
	Screen Enclosure Components	<b>58</b>
	Insulated Roof & Room Components	<b>66</b>
	Fasteners, Sealants, & Accessories	<b>84</b>
	Sovereign Aluminum Railing Kits & Accessories	<b>92</b>
	Comfort-Tite Storm Doors, Hardware, & Accessories	<b>98</b>



# Awning Components & Accessories

## **SERIES 100 - STEPDOWN AWNING COMPONENTS**

Stepdown Awning Sheets, Valance, Tube, Rafter, and other related products.





Stepdown Awnings

**Crest**  
**Aluminum**

Photo courtesy of Kohler Awning Co - New York



**101 - 2" Slidelock Awning Sheet**

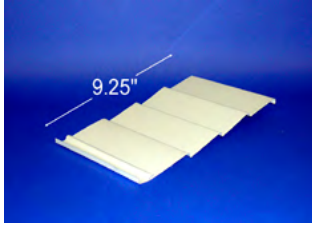

2" slidelock stepdown awning sheets slide together and feature a wide screw tray, screws are concealed. A 4-step sheet offering 9.25" coverage.

Catalog No	Item	Length	Pcs / Ctn	Gauge
10100	2" Slidelock Sheet	Custom	25	.019
10120	2" Slidelock Sheet	20'	25	.019
10124	2" Slidelock Sheet	24'	25	.019

**1013 - 3" Slidelock Awning Sheet**

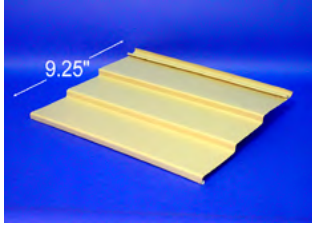

3" slidelock stepdown awning sheets slide together and feature a wide screw tray, screws are concealed. A 3-step sheet offering 9.25" coverage.

Catalog No	Item	Length	Pcs / Ctn	Gauge
101300	3" Slidelock Sheet	Custom	25	.019
101320	3" Slidelock Sheet	20'	25	.019
101324	3" Slidelock Sheet	24'	25	.019

**1013S - 3" Starter/Style Panel**

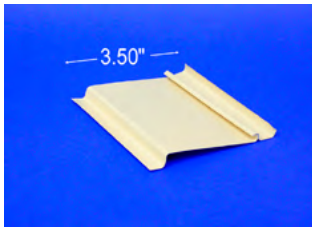

Used with either the 2" or 3" Slidelock sheet as a starter panel, or as a color feature stripe.

Catalog No	Item	Length	Pcs / Ctn	Gauge
1013S20	3" Starter/Style Panel	20'	20	.019

**101L - 2" Interlock Awning Sheet**

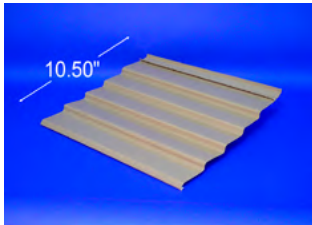

Sheets "snap-lock" together, similar to a siding panel, with our exclusive Crest "Z" lock for a perfect seamless appearance. A 5-step sheet offering 10.5" coverage.

Catalog No	Item	Length	Pcs / Ctn	Gauge
101L00	2" Interlock Sheet	Custom	20	.019
101L20	2" Interlock Sheet	20'	20	.019
101L24	2" Interlock Sheet	24'	20	.019

**501 - 31" Wide Awning Sheet**

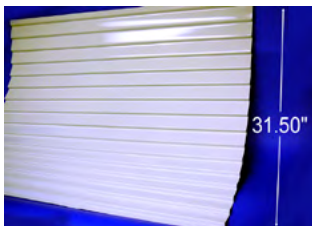

A high quality roll formed sheet, with very consistent steps. 31 1/2" coverage per sheet, creates a very rigid and strong awning, works very well for patio tops.

Catalog No	Item	Length	Pcs / Ctn	Gauge
50100	31" Wide Awning Sheet	Custom	10-15	.019
50112	31" Wide Awning Sheet	12'	15	.019
50120	31" Wide Awning Sheet	20'	10	.019
50124	31" Wide Awning Sheet	24'	10	.019

**502 - 31" Wide Vented Awning Sheet**

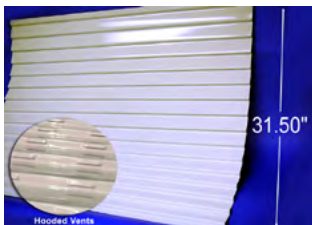

Similar to our #501 awning sheet, except this sheet has "hooded" vents on each step. Vents are perfectly aligned and provide air circulation along with filtered light.

Catalog No	Item	Length	Pcs / Ctn	Gauge
50200	31" Wide Vented Awning Sheet	Custom	10-15	.019
50212	31" Wide Vented Awning Sheet	12'	15	.019

Stepdown Awnings

SHEETS, VALANCE, & STRIPE AVAILABLE IN 22 COLORS! see page 17

## 102 - Regular Valance

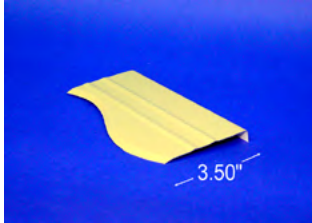

Our most popular valance, the lip faces towards the house. Packaged 25 pcs per carton with paper inter leaf to prevent scratching. Always a perfect match with our awning sheets.

Catalog No	Item	Length	Pcs / Ctn	Gauge
10212	Regular Valance	12'	25	.024

## 102A - Double-Lip Valance

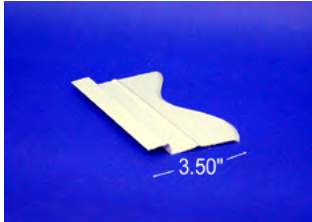

This valance has a lip that goes forward and then up. Packaged 25 pcs per carton with paper inter leaf to prevent scratching. Always a perfect match with our awning sheets.

Catalog No	Item	Length	Pcs / Ctn	Gauge
102A12	Double-Lip Valance	12'	26	.024

## 116 - Reverse Valance

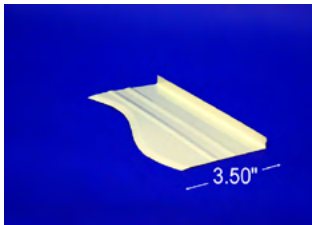

The lip faces away from the house. Packaged 26 pcs per carton with paper inter leaf to prevent scratching. Always a perfect match with our awning sheets.

Catalog No	Item	Length	Pcs / Ctn	Gauge
11612	Reverse Valance	12'	26	.024

## 141, 141A - 2" Awning Sheet Color Stripe

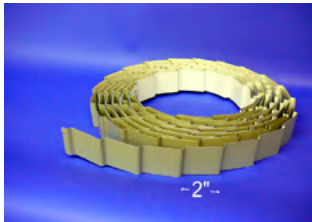

#141 fits our #101 2" slidelock sheet only. #141A fits our #501 wide sheet and #101L Interlock sheet. Used to create vertical color stripes. Sold in 100' rolls.

Catalog No	Item	Length	Pcs / Ctn	Gauge
14100	2" Slidelock Stripe	100'	1 Roll	.019
141A00	2" Wide Sheet/Interlock Stripe	100'	1 Roll	.019

## 305 - #6 x 3/8" SS 1/4" Hex Hd "A" Screw



Used primarily in the fabrication of aluminum stepdown awnings. Good sharp points with a 1/4" hex head.

Catalog No	Item	Length	Diameter	Pkg Qty
30500	#6 x 3/8" SS 1/4" Hex Hd "A" Screw	.375"	.14"	5000

## 119 - White Poly Caps



White plastic caps cover the exposed tips of screws for a finished look while also protecting your hands. Available in a soft flexible vinyl or hard rigid plastic.

Catalog No	Item	Length	Diameter	Pkg Qty
11900	Poly Caps	.50"	.25"	1000



**105/106 - .040 Heavy Rafter/ .032 Light Rafter**

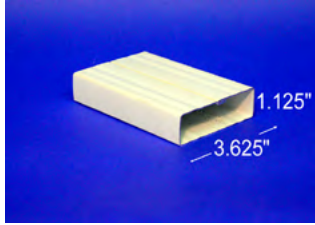

Our rafters are available in two wall thicknesses - .040 & .032. 1" lockseam tube fits perfectly inside. The ends are saw cut and perfectly square, not bent over. The .040 rafters are commonly used in construction of stepdown patio covers while .032 rafters are good for small porch awnings in light snow load areas..

Catalog No	Item	Length	Pcs / Ctn	Gauge
10517	.040 Heavy Rafter	17'	14	.040
10521	.040 Heavy Rafter	21'	14	.040
10524	.040 Heavy Rafter	24'	14	.040
10617	.032 Light Rafter	17'	14	.032
10621	.032 Light Rafter	21'	14	.032
10624	.032 Light Rafter	24'	14	.032

**126 - Rafter Saddle Connector**

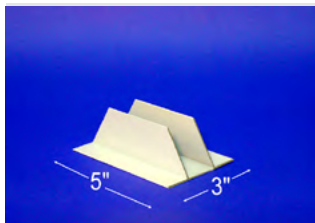

Fits on ends of rafters on stepdown patio covers and provides a strong wall attachment point.

Catalog No	Item	Length	Pcs / Ctn	Gauge
12600	Rafter Saddle Connector	3"x4"	100	.090

**107 - .032 1" Lockseam Tube**

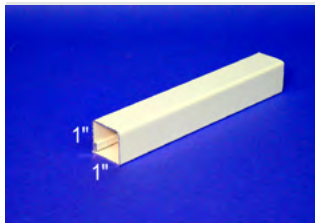

A quality .032 1"x1" lockseam tube used extensively in window awning fabrication. A perfectly square tube with square cut ends, this tube is ready to use right out of the carton. Also available in .024"

Catalog No	Item	Length	Pcs / Ctn	Gauge
10717	.032 1" Lockseam Tube	17'	56	.032
10721	.032 1" Lockseam Tube	21'	56	.032
10724	.032 1" Lockseam Tube	24'	56	.032

**111/112 - .040 Regular Wall Channel/ .063 Heavy Wall Channel**

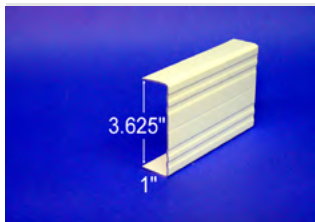

Wall channel is offered in two thicknesses. .040 is commonly used as a mounting channel for patio covers while the .063 is a heavier wall channel used for patio covers in extreme climates. Rafters fit inside to provide a wide and continuous mounting flange.

Catalog No	Item	Length	Pcs / Ctn	Gauge
11120	.040 Regular Wall Channel	20'	24	.040
11124	.040 Regular Wall Channel	24'	24	.040
11220	.063 Heavy Wall Channel	20'	24	.063
11224	.063 Heavy Wall Channel	24'	24	.063

**112A - Extruded Rafter Wall Hanger**

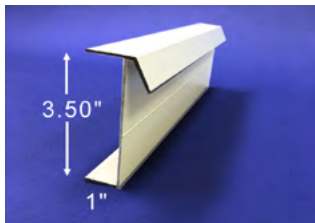

"Philadelphia" Style Hinged 2-pc Porch/Patio wall mount system consisting of a hinged extruded aluminum rafter wall channel-112A, and the 110F Awning Flasher. 105 or 106 Rafter fits inside the wall hanger and is part of the awning. The Wall Hanger/Awning Hook combination allows for simple Drop-In installation of the awning.

Catalog No	Item	Length	Pcs / Ctn	Gauge
112A24	Extruded Rafter Wall Hanger	24'	12	.060

### 108 - .040 1"x1" 90° Hanging Angle

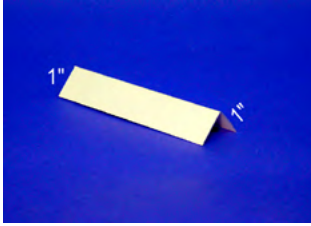

One of several angles used as a mounting flange where the awning meets the building. Also available in .032".

Catalog No	Item	Length	Pcs / Ctn	Gauge
10816	.040 1"x1" 90° Hanging Angle	16'	50	.040
10820	.040 1"x1" 90° Hanging Angle	20'	50	.040
108A16	.032 1"x1" 90° Hanging Angle	16'	50	.032

### 109 - .040 1"x1" 60° Hanging Angle

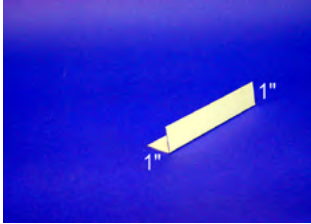

1"x1" angle pre-bent to compensate for pitch on top of window awnings.

Catalog No	Item	Length	Pcs / Ctn	Gauge
10916	.040 1"x1" 60° Hanging Angle	16'	50	.040

### 110 - .040 1¼"x¾" Hanging Angle

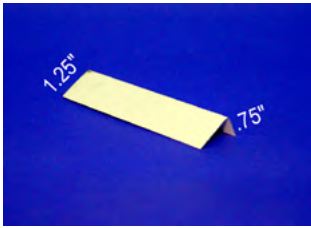

A popular mounting angle for awnings, versatile due to the two different size legs.

Catalog No	Item	Length	Pcs / Ctn	Gauge
11016	.040 1¼"x¾" Hanging Angle	16'	50	.040
11020	.040 1¼"x¾" Hanging Angle	20'	50	.040

### 110L - .040 1¼"x¾" Hanging Angle w/ Lines

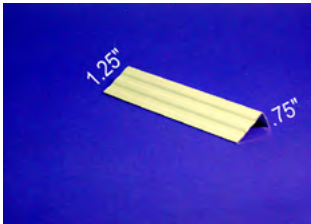

Same as our #110 angle, except this angle has 2 ridges for added stiffness.

Catalog No	Item	Length	Pcs / Ctn	Gauge
110L16	.040 1¼"x¾" Hanging Angle w/ Lines	16'	50	.040
110L20	.040 1¼"x¾" Hanging Angle w/ Lines	20'	50	.040

### 110A - .040 1"x1" Hanging Angle w/Hook

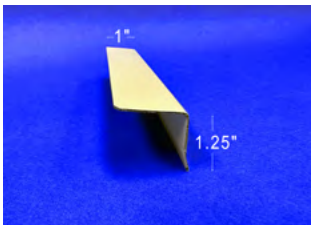

1" x 1" hanging angle with a slight curve on the back side provides additional rigidity when fastening to the host structure. A popular item amongst Chicago area awning fabricators!

Catalog No	Item	Length	Pcs / Ctn	Gauge
110A16	.040 1"x1" Hanging Angle w/Hook	16'	50	.040
110A20	.040 1"x1" Hanging Angle w/Hook	20'	50	.040

### 202 - 1"x1" Extruded Angle

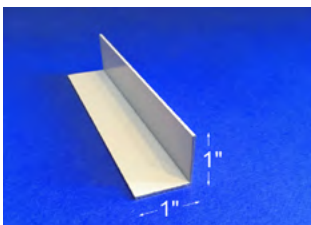

A heavy 1"x1" extruded angle used often as a mounting angle for stepdown patio covers.

Catalog No	Item	Length	Pcs / Ctn	Gauge
20216	1"x1" Extruded Angle	16'	25	.062

**110H - Extruded Awning Hook**

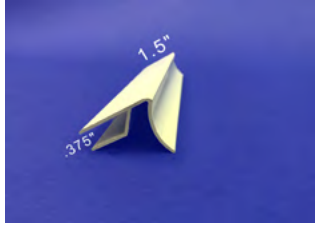

"Philadelphia" Style Hinged 2-pc Awning wall mount system consisting of a hinged extruded aluminum channel - hook - and the 110F Wall Mount - Awning Flasher. Awning sheet fits inside the wall hanger and is part of the awning. The Awning Hook/Flasher combination allows for simple Drop-In installation of the awning.

Catalog No	Item	Length	Pcs / Ctn	Gauge
110H24	Extruded Awning Hook	24'	16	.055

**110F - Extruded Awning Flasher**

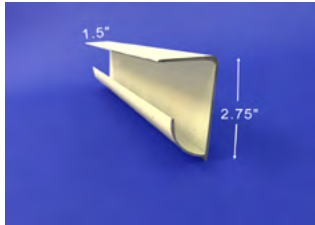

Wall Mounted attachment for the 2 pc "Philadelphia" Style Hinged Awning Mount System. Used with both 110H Awning Hook and the 112A Porch/Patio Hook.

Catalog No	Item	Length	Pcs / Ctn	Gauge
110F24	Extruded Awning Flasher	24'	10	.055

**103 - 1/2" U Channel**

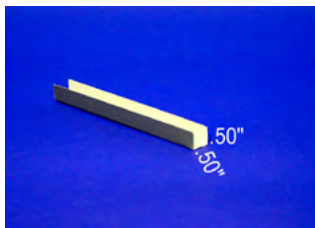

1/2"x1/2" U channel used to finish the edges and join awning top to the sides. Available in all 22 awning sheet colors.

Catalog No	Item	Length	Pcs / Ctn	Gauge
10316	1/2" U Channel	16'	50	.024

**113 - .040 1"x1" U Channel**

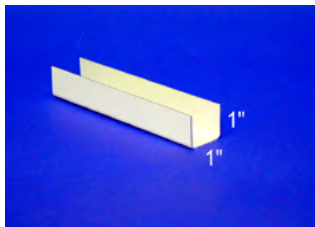

Used in awning construction to accept a 1" lockseam tube used for a front bar.

Catalog No	Item	Length	Pcs / Ctn	Gauge
11316	.040 1"x1" U Channel	16'	25	.040
11320	.040 1"x1" U Channel	20'	25	.040
11324	.040 1"x1" U Channel	24'	25	.040

**104 - 1/2" Rivet Angle**

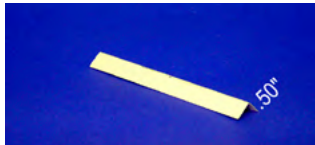

1/2"x1/2" angle used to join awning top to the sides. Available in all 22 awning sheet colors.

Catalog No	Item	Length	Pcs / Ctn	Gauge
10416	1/2" Rivet Angle	16'	50	.024

**326 - 3/16" SS Split Rivets**



Stainless 3/16" head x 3/8" shank used to fasten awning tops and sides with 1/2 rivet angle.

Catalog No	Item	Length	Diameter	Pkg Qty
32600	3/16" SS Split Rivets	.375"	.1875"	1000



## 207 - 1" & 1½" Extruded U Channel

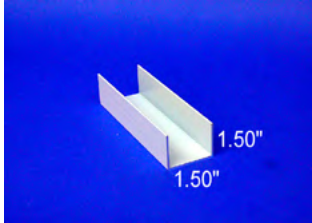

A heavy extruded 1½"x1½" u channel commonly used as a base for 1½" posts. Available in white or black. Also available in 1"x1", white only.

Catalog No	Item	Length	Pcs / Ctn	Gauge
20721	1½" Extruded U Channel	21'	24	.063
207A20	1" Extruded U Channel	20'	24	.063

## 115 - .040 Large Roll Formed Hat Section

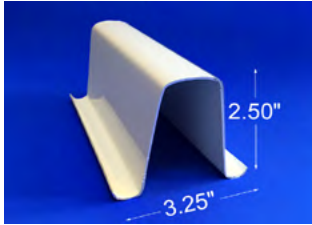

3½" high hat section used as a stiffener and mounting bar for support posts on canopies and small patio covers.

Catalog No	Item	Length	Pcs / Ctn	Gauge
11520	.040 Large Roll Formed Hat Section	20'	20	.040
11524	.040 Large Roll Formed Hat Section	24'	20	.040

## 115A - Extruded Hat Section

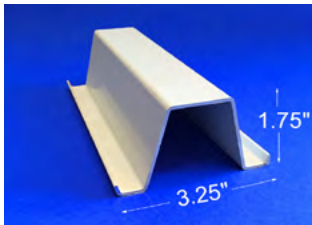

Extruded 1¾" high hat section used on smaller canopies and awnings as a stiffener and mounting bar.

Catalog No	Item	Length	Pcs / Ctn	Gauge
115A20	Extruded Hat Section	20'	12	.050
115A24	Extruded Hat Section	24'	12	.050

## 216 - Extruded "A" Beam



2 3/8" high "A" beam section used in the construction of stepdown aluminum canopies and small patio covers. 1" lockseam tube fits perfectly in the end to create a rounded awning front.

Catalog No	Item	Length	Pcs / Ctn	Gauge
21620	20' White Extruded "A" Beam	20'	10	.050
21624	24' White Extruded "A" Beam	24'	10	.050

## 217 - Extruded "A" Beam Wall Channel



Extruded "A" beam wall channel is used at the home to receive the #216 A Beam. Channel is slightly oversized in height to allow for A Beams cut on an angle to accommodate awning pitch.

Catalog No	Item	Length	Pcs / Ctn	Gauge
21720	Extruded "A" Beam Wall Channel	20'	10	.050
21724	Extruded "A" Beam Wall Channel	24'	10	.050

**121 - Tri Corner Brace**

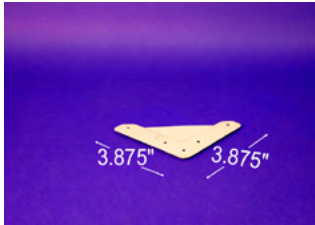

Used to join 1" lockseam tubes at front of awnings with having to miter them. Very strong and fast!

Catalog No	Item	Length	Pcs / Ctn	Gauge
12100	Tri Corner Brace	4"x4"	500	.040

**122 - 1" Tube Brace Connector**

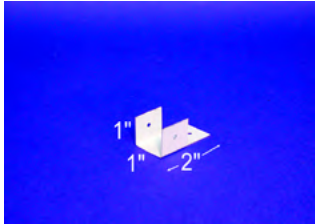

Used to fasten two pieces of 1" tube at right angles.

Catalog No	Item	Length	Pcs / Ctn	Gauge
12200	1" Tube Brace Connector	1"x1"	1000	.040

**12201 - 1" Tube Brace w/ Tabs**

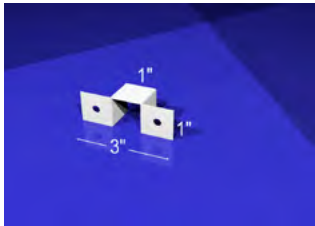

Used to fasten two pieces of 1" tube at right angles. This brace has two additional tabs for added strength.

Catalog No	Item	Length	Pcs / Ctn	Gauge
12201	1" Tube Brace w/ Tabs	1"x3"	1000	.040

**123 - 10" Brace Connector**

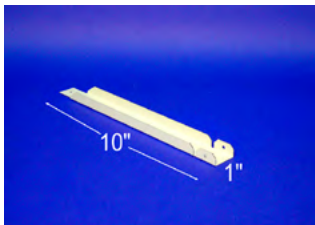

Used to connect 1" tube top braces to the front bar for added strength.

Catalog No	Item	Length	Pcs / Ctn	Gauge
12300	10" Brace Connector	10"	100	.040

**124 - 1" Tube Wall Bracket**



An adjustable wall bracket for attaching tube wall braces. Fits inside 1" lockseam tube.

Catalog No	Item	Length	Pcs / Ctn	Gauge
12400	1" Tube Wall Bracket	3"	500	.090

**412 - 1"x1" Corner Insert**



Used to join mitered 1" lockseam tubes at the front of the awning. Makes a strong neat connection.

Catalog No	Item	Length	Pcs / Ctn	Gauge
41200	1"x1" Corner Insert	3"x3"	100	.040

### 138 - 3" Aluminum Gutter

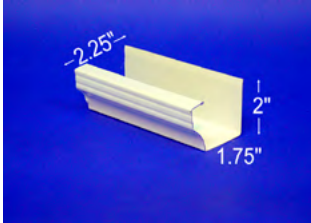

3" gutter used for step down patio covers and large door canopies. End caps and spout outlet available.

Catalog No	Item	Length	Pcs / Ctn	Gauge
13824	3" Aluminum Gutter	24'	24	.024

### 142 - 2" Aluminum Patio Gutter

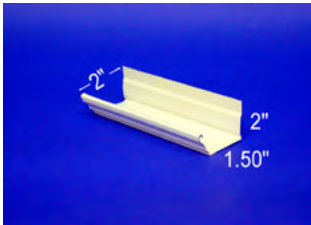

An extruded 2" gutter makes a great addition to door hoods and covers eliminating water runoff on steps.

Catalog No	Item	Length	Pcs / Ctn	Gauge
14200	2" Aluminum Patio Gutter	20'	20	.050"

### 125 - 1" Tube Swivel Bracket



An aluminum swivel casting allows for infinite adjustment of tube wall braces. 1" tube fits over the end.

Catalog No	Item	Length	Pcs / Ctn	Gauge
12500	1" Tube Swivel Bracket	-	25	-

### 129 - 20pc Bottle Brush Touch-up Kit



Custom matched touch up paint in a convenient set of 20 small bottles with a brush applicator cap.

Catalog No	Item	Length	Pcs / Ctn	Gauge
12900	Paint Touch-Up Kit	-	20	-



**208 - Bel Aire Front Rail w/ Gutter**

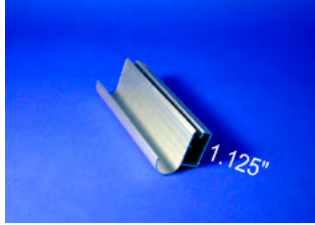

Front rail for Bel Aire awnings with a built-in drip rail/gutter. A nice addition to door hoods. Clear Anodize only.

Catalog No	Item	Length	Pcs / Ctn	Gauge
20816	Bel Aire Front Rail w/ Gutter	16'	25	.050

**209 - Bel Aire Front Rail**

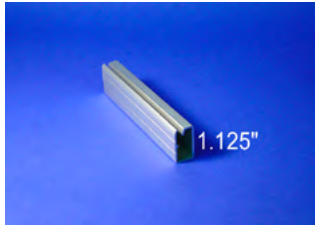

Front rail for Bel Aire awnings. Clear Anodize or White finish.

Catalog No	Item	Length	Pcs / Ctn	Gauge
20924-WH	White Bel Aire Front Rail	24'	25	.050
20916-AN	Anodized Bel Aire Front Rail	16'	25	.050

**209A - Bel Aire Front Rail w/ Gutter & Channel**

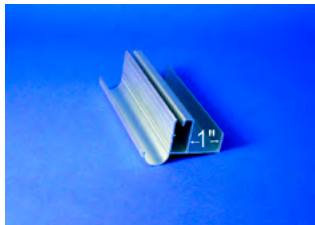

Front rail for Bel Aire awnings with a built-in drip rail/gutter and a channel to accept a 1" tube. A nice addition to door hoods. Clear Anodize only.

Catalog No	Item	Length	Pcs / Ctn	Gauge
209A16	Bel Aire Front Rail w/ Gutter & Channel	16'	25	.050

**210 - Bel Aire Side Rail**



Used to finish the side wing edges on Bel Aire awnings.

16' Lengths available in Clear Anodize only; 21' Lengths available in White only

Catalog No	Item	Length	Pcs / Ctn	Gauge
21016	Bel Aire Side Rail	16'	48	.050
21021	Bel Aire Side Rail	21'	25	.050

\* 21' Lengths available in White only, 25pcs per carton

**211 - Bel Aire Classic Side Rail**

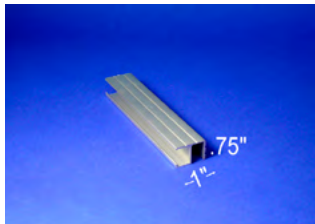

Used to join the top and sides of Bel Aire awnings using one shape.

Available in Clear Anodize or White finish.

Catalog No	Item	Length	Pcs / Ctn	Gauge
21116	Bel Aire Classic Side Rail	16'	25	.050

**12401 - Bel Aire Rail Wall Clip**



Adjustable wall clip used to fasten side rail support to house wall on the Bel Aire awning.

Catalog No	Item	Length	Pcs / Ctn	Gauge
12401	Bel Aire Wall Clip	2"	500	.080

## 212 - Bel Aire Wall Mount

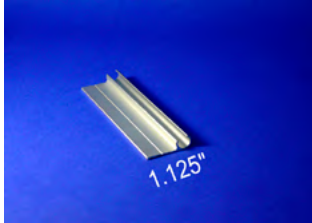

2 part wall attachment rail system for Bel Aire awnings. This part goes on the wall. Clear Anodize only.

Catalog No	Item	Length	Pcs / Ctn	Gauge
21216	Bel Aire Wall Mount	16'	40	.050

## 213 - Bel Aire Back Rail

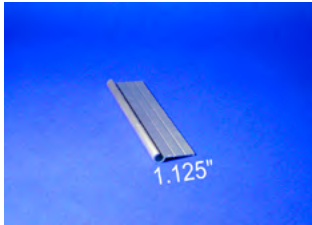

Used with our #212 to complete the 2 part hanging rail. This part attaches to the top rear of Bel Aire awning. Clear Anodize only.

Catalog No	Item	Length	Pcs / Ctn	Gauge
21316	Bel Aire Back Rail	16'	40	.050

## 213A - Bel Aire Back Rail w/ Channel

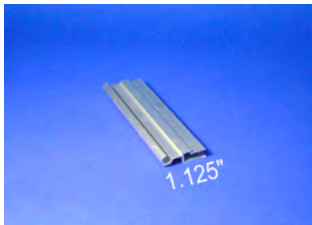

Similar to #213 although this part has an actual channel that accepts the awning sheet. Clear Anodize only.

Catalog No	Item	Length	Pcs / Ctn	Gauge
213A16	Bel Aire Back Rail w/ Channel	16'	40	.050

## 214 - Bel Aire End Rail

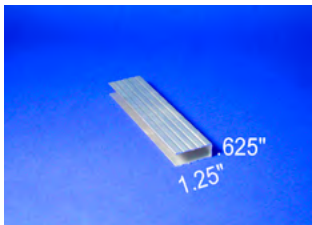

Used to finish the side wings of Bel Aire awnings at the house wall. Available in Clear Anodize or White finish.

Catalog No	Item	Length	Pcs / Ctn	Gauge
21416	Bel Aire End Rail	16'	40	.050

## 214A - Bel Aire 1/2"x3/4" End Rail

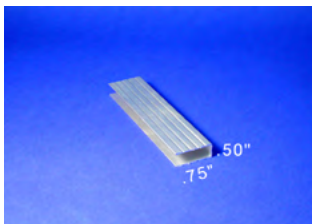

Used to finish the side wings of Bel Aire awnings at the house wall. Available in White only.

Catalog No	Item	Length	Pcs / Ctn	Gauge
214A16	Bel Aire 1/2"x3/4" End Rail	16"	40	.050

## 136 - Full Color Awning Brochure



A full color brochure shows all available colors. An excellent sales tool!

Catalog No	Item	Length	Pcs / Ctn	Gauge
13600	Full Color Awning Brochure	-	200	-

**131 - Tube Bender Machine - Complete**

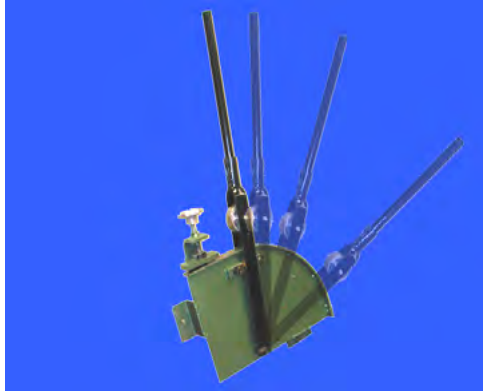

Used to produce bends in 1" lockseam tube and Bel Aire components. A heavy duty tool that will last. The bender has tabs for wall or table mounting. Follower block and inserts sold separately.

Catalog No	Item	Length
13100	Tube Bender Machine - Complete	-

**132 - #4A Insert for Bending Tube**



Required for bending 1" lockseam tube. Insert fits inside tube to prevent crushing.

Catalog No	Item	Length	Pcs / Ctn	Gauge
13200	#4A Insert for Bending Tube	18"	1	-

**13201 - #1 Insert for 210 Side Rail - Horizontal**



Required for bending #210 Bel Aire side rail horizontally.

Catalog No	Item	Length	Pcs / Ctn	Gauge
13201	#1 Insert for 210 Side Rail - Horizontal	18"	1	-

**13201-A - #2 Insert for 210 Side Rail - Vertical**



Required for bending #210 Bel Aire side rail vertically.

Catalog No	Item	Length	Pcs / Ctn	Gauge
13201-A	#2 Insert for 210 Side Rail - Vertical	18"	1	-

**13202 - #3B Insert for Classic Side Rail**



Required for bending #211 Bel Aire classic side rail.

Catalog No	Item	Length	Pcs / Ctn	Gauge
13202	#3B Insert for Classic Side Rail	18"	1	-

**133 - Universal Follower Block & Shims**

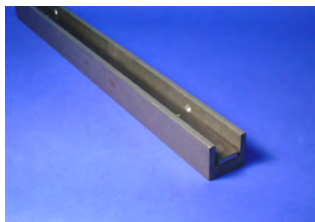

Used in all bending applications, fits over tube to prevent splitting.

Catalog No	Item	Length	Pcs / Ctn	Gauge
13300	Universal Follower Block & Shims	18"	1	-



## Awning Sheets, Valance & Stripe available in 22 colors!

<b>CW</b> Colonial White	<b>BL</b> Raven Black	<b>BR</b> Autumn Brown	<b>CR</b> Vivid Cream
<b>FR</b> Fern Green	<b>IG</b> Ivy Green	<b>JY</b> Jonquil Yellow	<b>HB</b> Heron Blue
<b>TC</b> Terra Cotta	<b>CG</b> Cadet Grey	<b>HR</b> Hunter Red	<b>IB</b> Imperial Brown ★
<b>AI</b> Antique Ivory ★	<b>CA</b> Canyon Red ★	<b>WBG</b> Wedgewood Blue Gloss	<b>WB</b> Wedgewood Blue ★
<b>HG</b> Hunter Green ★	<b>CL</b> Sierra Clay ★	<b>WK</b> Wicker ★	<b>MR</b> Maroon
<b>MT</b> Mocha Tan	<b>WH</b> White		

★Matte Finish



# **Deck, Patio, & Walkway Cover Pre-Cut Kits & Lineals**

**SERIES 700 - DECK, PATIO, & WALKWAY COVERS**

**Extruded & Roll Formed Lineals for Residential or Commercial Covers & Canopies**



Photo courtesy of Callaway Awning Co - Delaware

## 701 - .024 8" x 3" Flat Pan

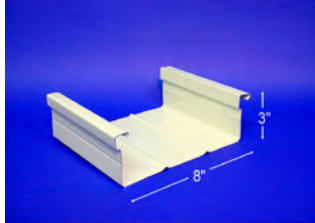

8" wide x 3" deep Roll formed aluminum flat pan in .024 thickness. Best lock in the industry. Specify color on top or bottom when ordering. Stock or custom lengths.

Catalog No	Item	Length	Pcs / Ctn	Gauge
70100	.024 8" x 3" Flat Pan	Custom	8	.024
70120	.024 8" x 3" Flat Pan	20'	8	.024
70124	.024 8" x 3" Flat Pan	24'	8	.024

White, Colonial White, Almond, Black, Brown, Bronze (both sides), & Clay. Colors are White on one side.

## 702 - .032 8" x 3" Flat Pan

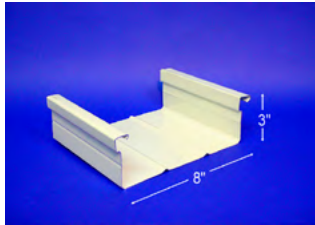

8" wide x 3" deep Roll formed aluminum flat pan in .032 thickness. A strong pan with exceptional load capacity. Stock or custom lengths.

Catalog No	Item	Length	Pcs / Ctn	Gauge
70200	.032 8" x 3" Flat Pan	Custom	8	.032
70220	.032 8" x 3" Flat Pan	20'	8	.032
70224	.032 8" x 3" Flat Pan	24'	8	.032

Available in White & Colonial White All colors are White on one side.

## 700 - .040 8" x 3" Flat Pan

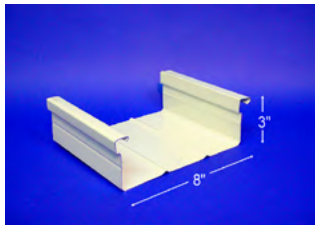

8" wide x 3" deep Roll formed aluminum flat pan in .040 thickness. A super strong pan developed for our "snow belt" and Canadian customers. Stock or custom lengths.

Catalog No	Item	Length	Pcs / Ctn	Gauge
70000	.040 8" x 3" Flat Pan	Custom	8	.040
70020	.040 8" x 3" Flat Pan	20'	8	.040
70024	.040 8" x 3" Flat Pan	24'	8	.040

Available in White, Clay, & Matte Black All colors are White on one side.

## 724 - 8" Flat Pan Leaf Guard

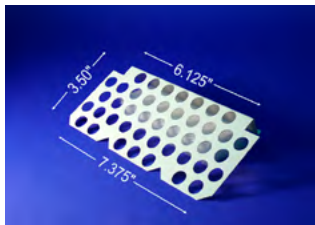

Stamped aluminum leaf guard snaps into end of pan at gutter, helps to prevent leaves from building up in gutter, fits all gauges of our flat pans.

Catalog No	Item	Length	Pcs / Ctn	Gauge
72400	8" Flat Pan Leaf Guard	8"	50	-

Available in White

## 726 - 4" Wide Flat Pan Skylight

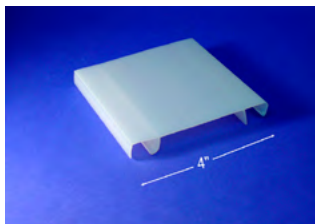

Provista® 4" skylights allow soft light to filter down through your patio cover to create a comfortable warm atmosphere. Available in 10', 11', 12', 13', 16', 17', 18', 20', 24'.

Catalog No	Item	Length	Pcs / Ctn	Gauge
72620	4" Wide Flat Pan Skylight	20'	1	-
72624	4" Wide Flat Pan Skylight	24'	1	-

Available in Translucent White

## 726F - Flat Pan Skylight Foam Bug Plug

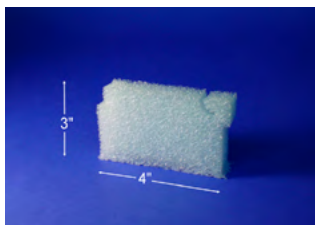

Foam plastic plugs used to close ends of skylights to prevent bugs from entering. 4" wide Snap into place easily.

Catalog No	Item	Length	Pcs / Ctn	Gauge
726F	Flat Pan Skylight Foam Bug Plug	4"	20	-

Available in White

**736 - .024 12" x 3" W Pan**

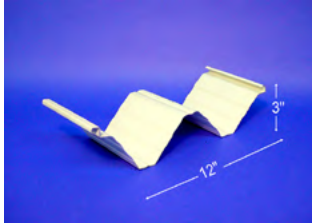

12" wide x 3" deep Roll formed aluminum "W" or "twin v" pan in .024 thickness. Available in a wide variety of colors

Catalog No	Item	Length	Pcs / Ctn	Gauge
73600	.024 12" x 3" W Pan	Custom	8	.024
73620	.024 12" x 3" W Pan	20'	8	.024
73624	.024 12" x 3" W Pan	24'	8	.024

White, Colonial White, Almond, Black, Brown, Bronze (both sides), & Clay. Colors are White on one side.

**737 - .032 12" x 3" W Pan**

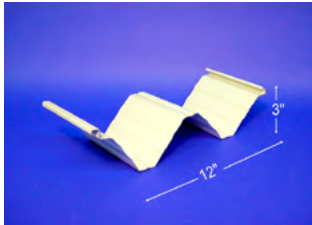

12" wide x 3" deep Roll formed aluminum "W" or "twin v" pan in .032 thickness. Excellent strength and span capability. Stock or custom lengths.

Catalog No	Item	Length	Pcs / Ctn	Gauge
73700	.032 12" x 3" W Pan	Custom	8	.032
73720	.032 12" x 3" W Pan	20'	8	.032
73724	.032 12" x 3" W Pan	24'	8	.032

Available in White & Colonial All colors are White on one side.

**738 - .040 12" x 3" W Pan**

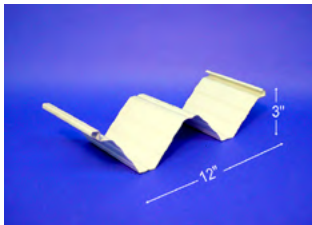

12" wide x 3" deep Roll formed aluminum "W" pan in .040 thickness. Super strong panel designed for our "snow belt" and Canadian customers. Stock or custom lengths.

Catalog No	Item	Length	Pcs / Ctn	Gauge
73800	.040 12" x 3" W Pan	Custom	8	.040
73820	.040 12" x 3" W Pan	20'	8	.040
73824	.040 12" x 3" W Pan	24'	8	.040

Available in White, Clay & Matte Black All colors are White on one side.

**747 - 12" W Pan Foam Bug Plug (2 per pan)**

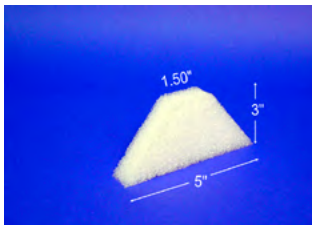

Foam bug plug, closes ends of roof pans when an enclosure is installed under a cover. 2 per panel required.

Catalog No	Item	Length	Pcs / Ctn	Gauge
74700	12" W Pan Leaf Guard (2 per pan)	5"x3"	50	-

Available in White



**705 - 3"x5" Extruded Gutter**

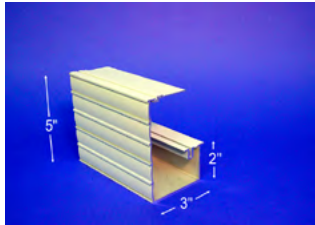

3" Deep and 5" High Accepts 3- 1" color stripes. Utilizes an extruded hold down bar or clip to tie pans down to top of gutter. Built in screw bosses and heavy .062 thickness.

Catalog No	Item	Length	Pcs / Ctn	Gauge
70520	3"x5" Extruded Gutter	20'	4	.062
70524	3"x5" Extruded Gutter	24'	4	.062

Available White, Brown, Bronze, Clay, and now **BLACK!**

**722 - Hold Down Bar - 3"x5" Gutter**

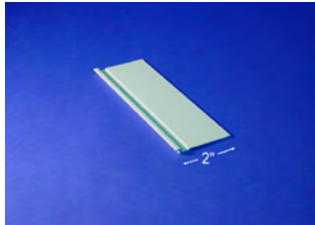

Extruded hold down bar fits into slot at top of extruded gutter. Ties pans to gutter top. .062 thickness. Lifts up for gutter cleaning. Available in white only.

Catalog No	Item	Length	Pcs / Ctn	Gauge
72212	Hold Down Bar - 3"x5" Gutter	12'	20	.062

**706 - 12" Gutter Splice - 3"x5" Gutter**

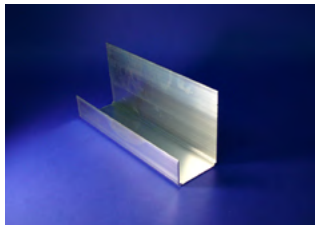

Used to join 2 pieces of 3x5 gutter, .062 thickness Available in mill finish only.

Catalog No	Item	Length	Pcs / Ctn	Gauge
70600	12" Gutter Splice - 3"x5" Gutter	12"	1	.062

**708 - Welded Outside Corner - 3"x5" Gutter**

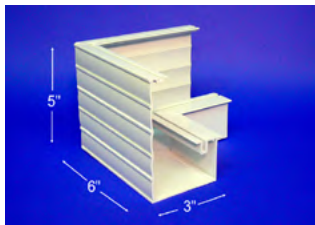

3" deep and 5" high used on full perimeter units with gutter on all four sides. Corners are welded for added strength. Includes splice plates .062 thickness.

Catalog No	Item	Length	Pcs / Ctn	Gauge
70800	Welded Outside Corner - 3"x5" Gutter	6"x6"	4	.062

Available White, Brown, Bronze, & Clay

**709 - Welded Inside Corner - 3"x5" Gutter**

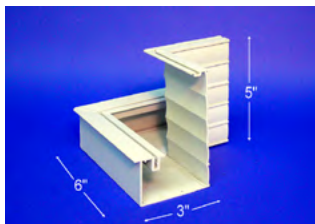

3" deep and 5" high used on full perimeter units with gutter on all sides when an inside corner is required. Welded for added strength, includes splice plates .062 thickness

Catalog No	Item	Length	Pcs / Ctn	Gauge
70900	Welded Inside Corner - 3"x5" Gutter	6"x6"	4	.062

Available White, Brown, Bronze, & Clay

**720 - Foam Fascia Plug - 3"x5" Gutter**

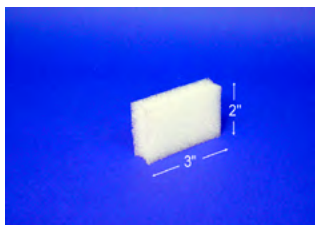

Foam plug used to block the end of the gutter where it meets the side fascia to seal against leaks. Installed with sealant at each end of gutter.

Catalog No	Item	Length	Pcs / Ctn	Gauge
72000	Foam Fascia Plug - 3"x5" Gutter	3"x2"x2"	20	-

Available in White

### 705A - 5"x5" Extruded Gutter

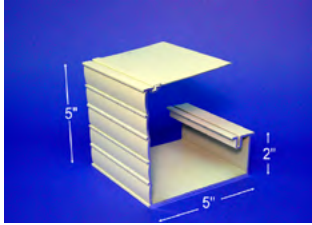

5" Deep and 5" High Offered exclusively by Crest Aluminum, the 5x5 gutter holds up to 66% more water than the 3x5 gutter. The 5x5 also allows for the use of commercial size spouts which virtually eliminate the need for leaf guards. Easiest gutter for the homeowner to clean out.

Catalog No	Item	Length	Pcs / Ctn	Gauge
705A20	5"x5" Extruded Gutter	20'	1	.100
705A24	5"x5" Extruded Gutter	24'	1	.100

Available White, Brown, Bronze, Clay, and now **BLACK!**

### 722A - Hold Down Bar - 5"x5" Gutter

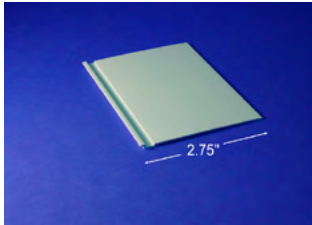

Extruded hold down bar fits into slot at top of extruded gutter. Ties pans to gutter top. .062 thickness. Lifts up for gutter cleaning. Available in white only.

Catalog No	Item	Length	Pcs / Ctn	Gauge
722A12	Hold Down Bar - 5"x5" Gutter	12'	20	.062

### 706A - 12" Gutter Splice - 5"x5" Gutter

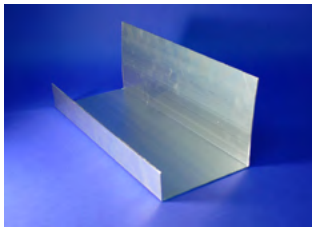

Used to join 2 pieces of 5x5 gutter, .062 thickness Available in mill finish only.

Catalog No	Item	Length	Pcs / Ctn	Gauge
706A00	12" Gutter Splice - 5"x5" Gutter	12"	1	.062

### 707 - 1"x5" Extruded Side Fascia

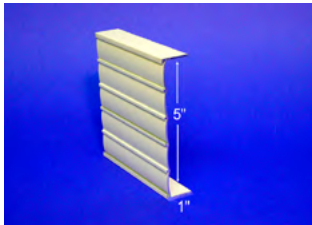

Extruded side fascia caps ends of both styles of gutter when building units with gutter on front only. Accepts 3 color bands of 1" stripe.

Catalog No	Item	Length	Pcs / Ctn	Gauge
70720	1"x5" Extruded Side Fascia	20'	10	.062
70724	1"x5" Extruded Side Fascia	24'	10	.062

Available White, Brown, Bronze, Clay, and now **BLACK!**

### 72001 - Foam Fascia Plug - 5"x5" Gutter

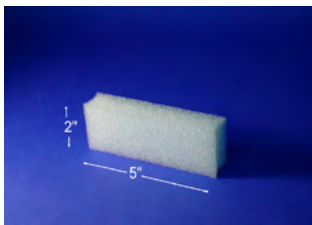

Foam plug used to block the end of the gutter where it meets the side fascia to seal against leaks. Installed with sealant at each end of gutter.

Catalog No	Item	Length	Pcs / Ctn	Gauge
72001	Foam Fascia Plug - 5"x5" Gutter	5"x2"x2"	20	-

Available in White

## 716 - Extruded J Hanging Rail

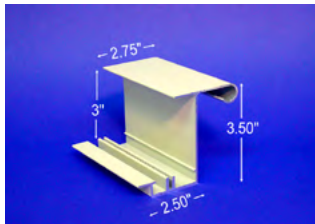

Extruded "J" rail is used with "J" wall mount to create a strong, adjustable hanging system for patio covers. Built in screw boss and drain. Screw boss is above the lower trough and eliminates leakage at this point. Accepts neoprene gasket, enables you to build the cover in the shop or on the ground and drop in place on the wall mount.

Catalog No	Item	Length	Pcs / Ctn	Gauge
71620	Extruded J Hanging Rail	20'	4	.062
71624	Extruded J Hanging Rail	24'	4	.062
Available White, Brown, Bronze, & Clay				

## 717 - Extruded J Wall Mount

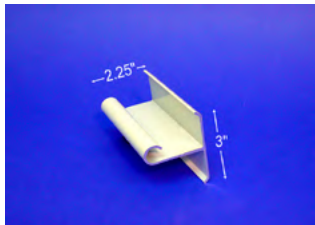

Extruded "J" wall mount is used with "J" hanging rail to create a strong adjustable hanging system for patio covers. Mount on wall and drop "J" rail into position. The "J" rail system enables you to build the cover in the shop or on the ground.

Catalog No	Item	Length	Pcs / Ctn	Gauge
71720	Extruded J Wall Mount	20'	4	.062
71724	Extruded J Wall Mount	24'	4	.062
Available White, Brown, Bronze, & Clay				

## 719 - 1/4" x 3.25" x 50' Neoprene Gasket Tape

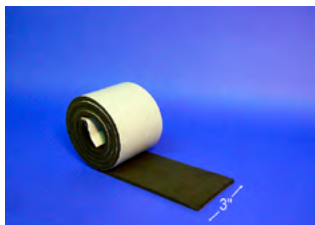

Real neoprene rubber tape with adhesive backing to adhere to "J" rail which prevents leaks at the back of the cover. 3" wide x 1/4" thick. Slightly more expensive but saves time and money spent on service calls.

Catalog No	Item	Length	Pcs / Ctn	Gauge
71900	1/4" x 3.25" x 50' Neoprene Gasket Tape	50'	1 Roll	.25"

## 761 - Extruded G Hanging Rail

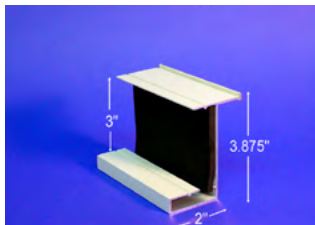

Extruded "G" hanging rail is used with #762 "G" wall mount. Accepts neoprene gasket tape to catch pan leaks. Has built in rear gutter, allows minor adjustment for pitch of cover. Should be assembled prior to installing on wall.

Catalog No	Item	Length	Pcs / Ctn	Gauge
76120	Extruded G Hanging Rail	20'	4	.062
76124	Extruded G Hanging Rail	24'	4	.062
Available White & Clay				

## 762 - Extruded G Wall Mount

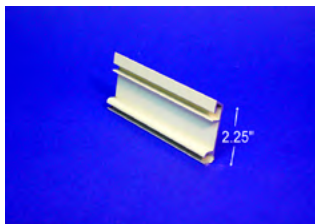

Extruded "G" wall mount is used with #761 "G" hanging rail, upper slot accepts flashing. Should be assembled with "G" rail prior to installing on wall.

Catalog No	Item	Length	Pcs / Ctn	Gauge
76220	Extruded G Wall Mount	20'	4	.062
76224	Extruded G Wall Mount	24'	4	.062
Available White				

## 721 - G Rail Flashing

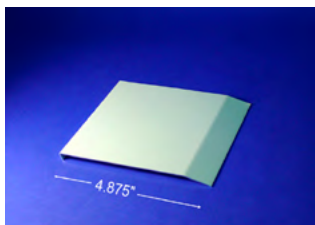

"G" wall mount flasher slips into upper slot at top of wall mount, helps prevent leaking at back of cover.

Catalog No	Item	Length	Pcs / Ctn	Gauge
72110	G Rail Flashing	10'	1	-
Available in White				

## 741 - 3"x5" .050" Roll Formed Gutter

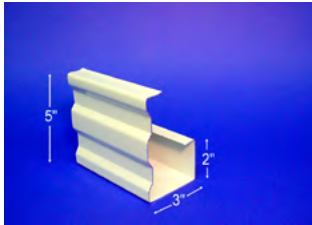

3" deep x 5" high, with 1" x 1/8" offsets for strength and appearance. Extra heavy .050 thickness. Used on our Suburb-A-Port series covers.

Catalog No	Item	Length	Pcs / Ctn	Gauge
74120	3"x5" .050" Roll Formed Gutter	20'	6	.050
74124	3"x5" .050" Roll Formed Gutter	24'	6	.050

Available White & Colonial White

## 743 - 1"x5" .050" Roll Formed Side Fascia

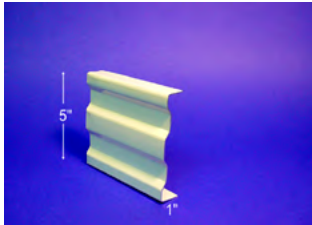

1" deep x 5" high, with 1" x 1/8" offsets for strength and appearance. Fits over and caps the end of the #741 gutter fascia. Extra heavy .050 thickness. Used on our Suburb-A-Port series covers.

Catalog No	Item	Length	Pcs / Ctn	Gauge
74321	3"x5" .050" Roll Formed Gutter	21'	10	.050
74324	3"x5" .050" Roll Formed Gutter	24'	10	.050

Available White & Colonial White

## 748A - Welded Outside Corner - 3"x5" RF Gutter

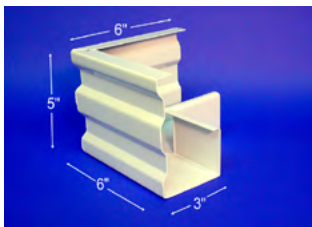

Roll formed and welded outside corner matches gutter perfectly for a "seamless" appearance when building full gutter units. Includes splice plates. Heavy .050 aluminum.

Catalog No	Item	Length	Pcs / Ctn	Gauge
748A00	Welded Outside Corner - 3"x5" RF Gutter	6"x6"	4	.050

## 748I - Welded Inside Corner - 3"x5" RF Gutter

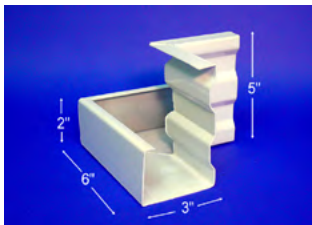

Roll formed and welded inside corner enables you to build around chimneys and other obstructions when building full gutter units. Includes splice plates. Heavy .050 aluminum.

Catalog No	Item	Length	Pcs / Ctn	Gauge
748I00	Welded Inside Corner - 3"x5" RF Gutter	6"x6"	4	.050

## 744 - 1"x5" RF Corner Cap for RF Gutter



1" deep x 5" high, with 1" x 1/8" offsets for strength and appearance. Fits over and caps the end of the #741 gutter fascia. Extra heavy .050 thickness. Used on our Suburb-A-Port series covers.

Catalog No	Item	Length	Pcs / Ctn	Gauge
74400	1"x5" RF Corner Cap for RF Gutter	1"x5"	50	-

Available White & Colonial White

## 745 - Water Deflector

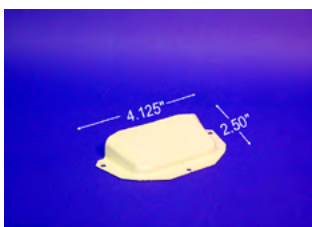

Water deflectors are used in place of spouts to direct water away from cover. No outlet needed, just drill a 2" hole and cap with the deflector.

Catalog No	Item	Length	Pcs / Ctn	Gauge
74500	Water Deflector	4 1/2"x3"	50	-

Available in White, Brown, & Colonial White



# 700

## ULTRA<sup>series</sup>

### EXTRUDED PERIMETER



### *Patio Covers*

The ULTRA 700 Series is made up of all extruded aluminum components. It is our top of the line and offers great quality, strength and versatility in color offerings and available configurations. Available in 4 perimeter colors; White, Brown, Bronze, and Clay. Other features include: hold down bars for roof pans to facilitate gutter cleaning, exclusive 5"x5" gutter increases water carrying capacity by 65% and allows for the use of commercial size spouting eliminating the need for leaf guards.



### *Commercial Canopies*

All gutters and back rails have built-in "screw bosses" and pans are pre-punched shortening installation time by eliminating the need to pre-drill pilot holes. The durability and rigidity of an extruded product should not be understated. These covers are tougher, less prone to damage and are of a much heavier metal thickness. You will pay a little more now, but you will be ensured of these and more benefits for years to come.



### *Carports*

The ULTRA 700 Series is available in 3 unique configurations, designed to accommodate any desired application. The "J" Hanging Rail offers a 2 piece hinged mounting system which allows you to build the unit in the shop, on the wall, or on the ground. For free-standing units or covers that may require draining at the back of the cover, our Gutter Front and Rear or Full Perimeter cover (gutter on all four sides) allow downspouts to be located in several different places.

All ULTRA 700 Series covers include stainless steel fasteners for installation of roof panels & color matched fasteners for assembling the perimeter.

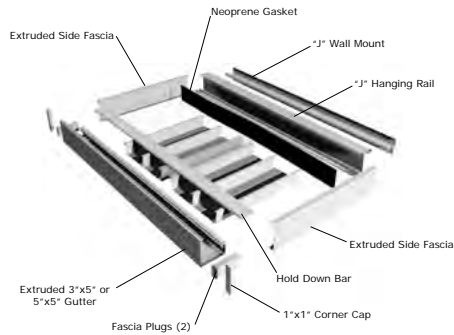

## "J" Hanging Rail Style

- "J" Hanging Rail patio cover kits have built-in front gutter. Our most popular cover
- Massive 5"x5" Front gutter. .100" wall thickness. Makes cleaning out gutter a breeze & eliminates need for leaf guards.
- Extra heavy extruded aluminum perimeter. Perfect for screen rooms or deck covers.
- Exclusive Crest "J-Rail" mounting system allows you to build anywhere.

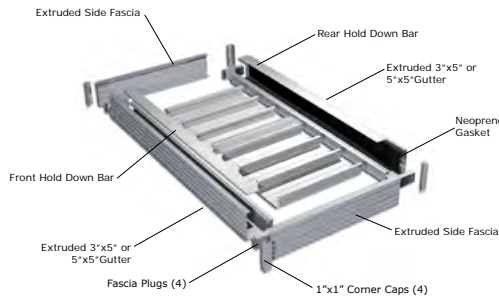

## Gutter Front & Back Style

- Patio cover kits have built-in gutter on front and back.
- Massive 5"x5" Front gutter .100" wall thickness. Makes cleaning out gutter a breeze & eliminates need for leaf guards.
- Extra heavy extruded aluminum perimeter. Perfect for carports or walkway covers.
- Drains from either front or back.
- Neoprene gasket at rear eliminates call-backs.
- No need to drill holes! All pans are pre-punched. Screw bosses in gutter.

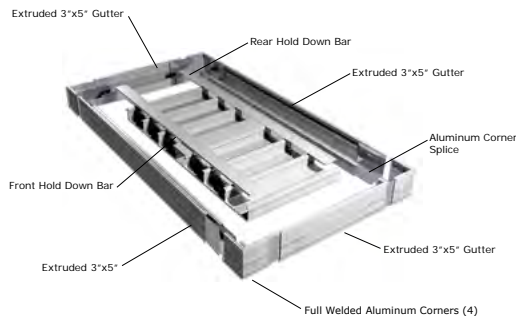

## Full Perimeter Style

- Full Perimeter patio cover kits have heavy 3"x5" extruded gutter on all four sides.
- Units are shipped with Crest welded corners
- No need to drill holes! All pans are pre-punched. Screw bosses in gutter.
- Units packaged complete with stainless fasteners for pans.
- Exclusive welded corners on all four sides.

## Available Colors

Perimeter						
	Polar White	Sierra Clay	Chestnut Brown	Quaker Bronze	Black	
.024 Flat & W Pans						
	Polar White	Colonial White	Sierra Clay	Chestnut Brown	Quaker Bronze	Black
.032 Flat & W Pans						
	Polar White	Colonial White				
.040 Flat & W Pans						
	Polar White	Colonial White	Sierra Clay			



## 700 Ultra Series Extruded Square Foot Price List

### "J" Hanging Rail Style

#### *Exclusive Ultra Series Features...*

- "J" Hanging Rail patio cover kits have built-in front gutter. Our most popular cover
  - Massive 5"x5" Front gutter. .100" wall thickness. Makes cleaning out gutter a breeze & eliminates need for leaf guards.
  - Extra heavy extruded aluminum perimeter. Perfect for screen rooms or deck covers.
    - Exclusive Crest "J-Rail" mounting system allows you to build anywhere.
      - Build on the ground or on the wall, and tilt up to proper elevation.
      - Neoprene gasket at rear eliminates call-backs.
  - No need to drill holes! All pans are pre-punched. Screw bosses in gutter and J-Rail.
    - Available Options: Skylites
    - Perimeter Colors: White, Brown, Bronze, Clay & Black
    - Pan Colors\*\*: White • Colonial White • Brown • Clay • Bronze • Black
- (\*\* Black, Bronze and Brown .024 only; Colonial White in .024 and .032 only)

**700**  
**ULTRA** series  
EXTRUDED PERIMETER

700 Ultra Series Extruded  
Square Foot Price List

## "J" Hanging Rail Style

Patio Cover Exploded Diagram

*Extruded Aluminum components make all the difference...*

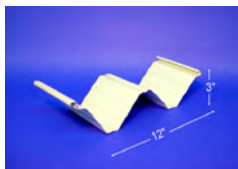
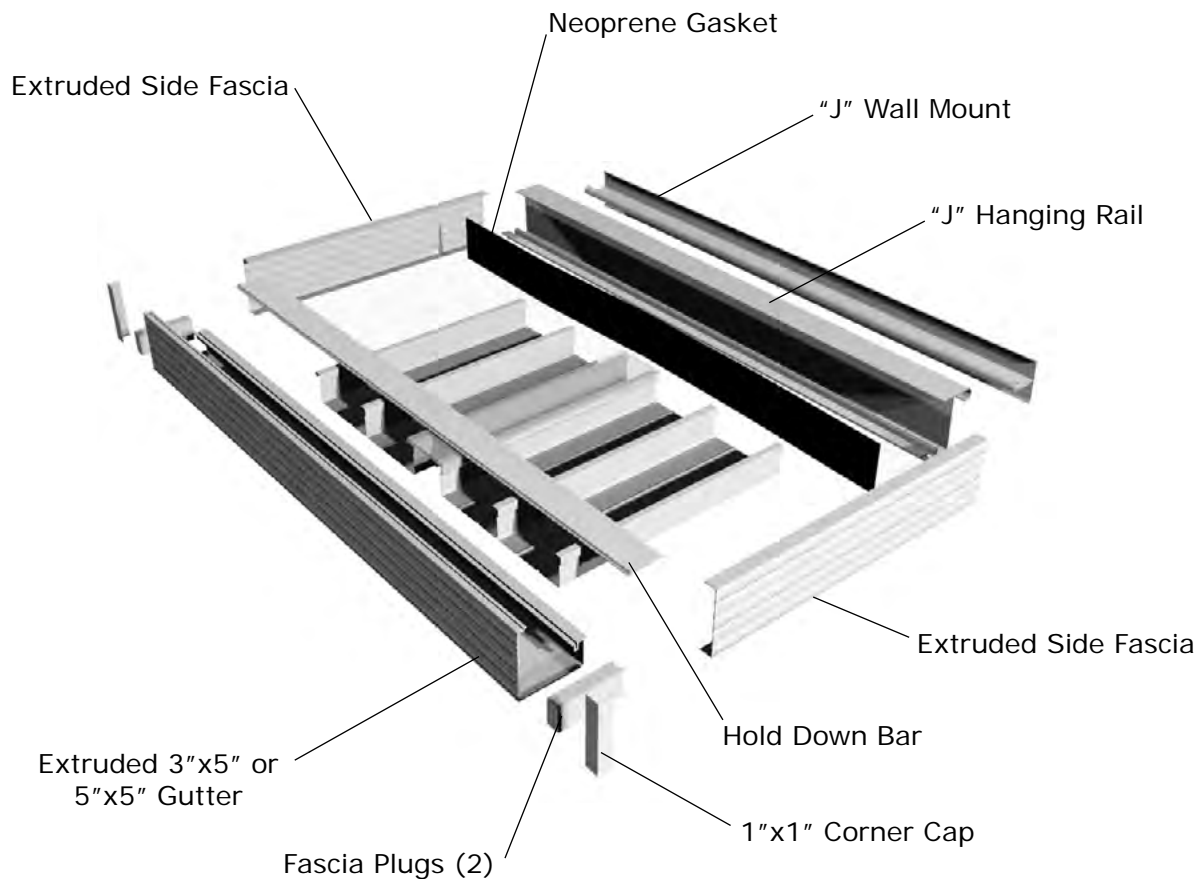

12" W Pan

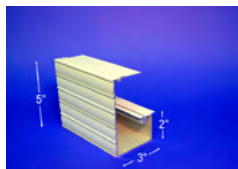

3"x5" Gutter

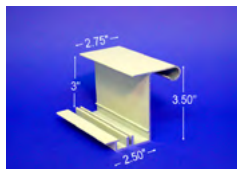

"J" Hanging Rail



"J" Wall Mount

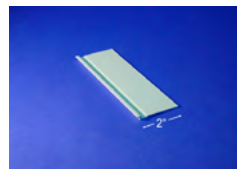

Hold Down Bar

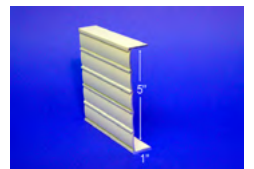

Side Fascia

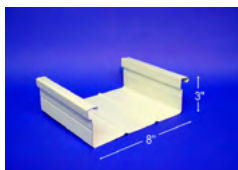

8" Flat Pan

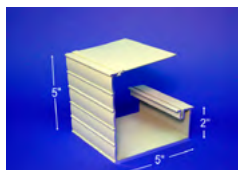

5"x5" Gutter

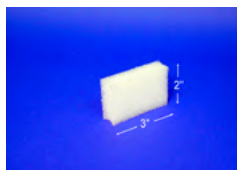

Fascia Plug

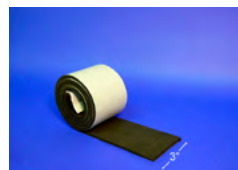

Neoprene Gasket

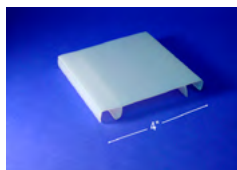

4" Skylites  
*\*Available option*





## 700 Ultra Series Extruded Square Foot Price List

### Full Perimeter Style

#### *Exclusive Ultra Series Features...*

- Full Perimeter patio cover kits have heavy 3"x5" extruded gutter on all four sides.
  - Units are shipped with Crest welded corners
- No need to drill holes! All pans are pre-punched. Screw bosses in gutter.
  - Units packaged complete with stainless fasteners for pans.
    - Available Options: Skylites
  - Perimeter Colors: White, Brown, Bronze, Clay & Black
- Pan Colors\*\*: White • Colonial White • Brown • Clay • Bronze • Black  
(\* Black, Bronze and Brown .024 only; Colonial White in .024 and .032 only)

700 **ULTRA** series EXTRUDED PERIMETER

700 Ultra Series Extruded Square Foot Price List

Full Perimeter Style Patio Cover Exploded Diagram

Extruded Aluminum components & welded corners make all the difference...

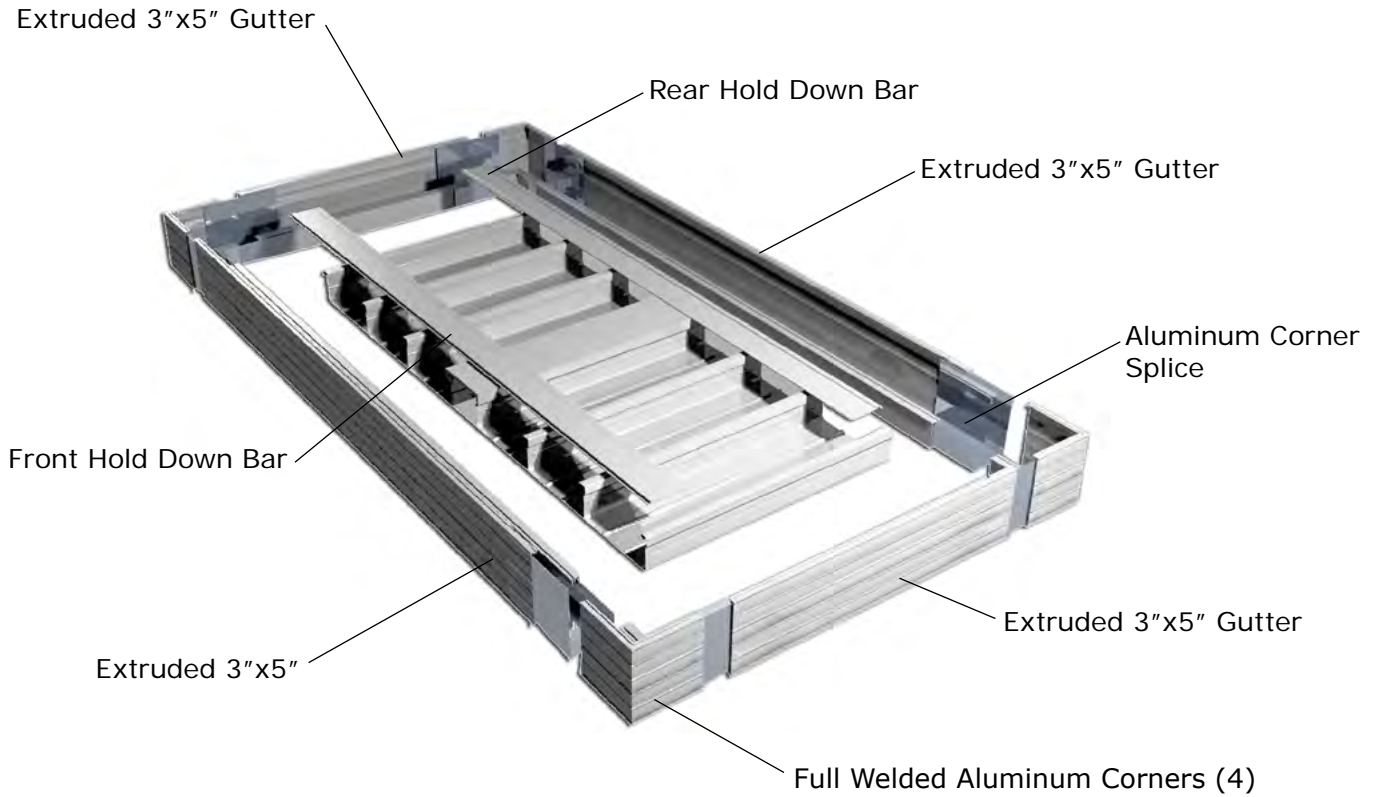

12" W Pan

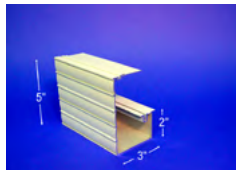

3"x5" Gutter

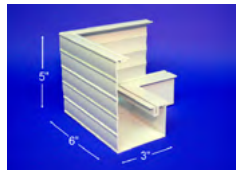

Welded Corner

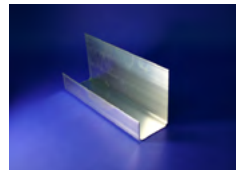

Corner Splice

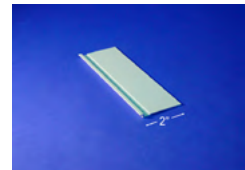

Hold Down Bar

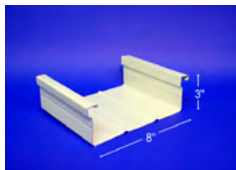

8" Flat Pan

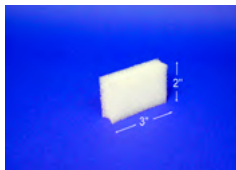

Fascia Plug

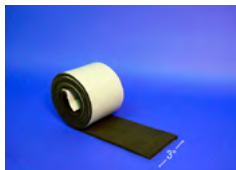

Neoprene Gasket

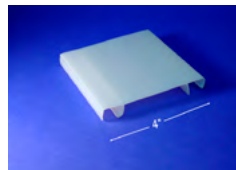

4" Skylites  
\*Available option



## 700 Ultra Series Extruded Square Foot Price List

### Gutter Front & Back Style

*Exclusive Ultra Series Features...*

- Patio cover kits have built-in gutter on front and back.
  - Massive 5"x5" Front gutter. .100" wall thickness. Makes cleaning out gutter a breeze & eliminates need for leaf guards.
  - Extra heavy extruded aluminum perimeter. Perfect for carports or walkway covers.
    - Drains from either front or back.
    - Neoprene gasket at rear eliminates call-backs.
  - No need to drill holes! All pans are pre-punched. Screw bosses in gutter.
    - Available Options: Skylites
  - Perimeter Colors: White, Brown, Bronze, Clay & Black
  - Pan Colors\*\*: White • Colonial White • Brown • Clay • Bronze • Black
- (\*\* Black, Bronze and Brown .024 only; Colonial White in .024 and .032 only)



700  
**ULTRA** series  
EXTRUDED PERIMETER

700 Ultra Series Extruded  
Square Foot Price List

# Gutter Front & Back Style

## Patio Cover Exploded Diagram

*Extruded Aluminum components make all the difference...*

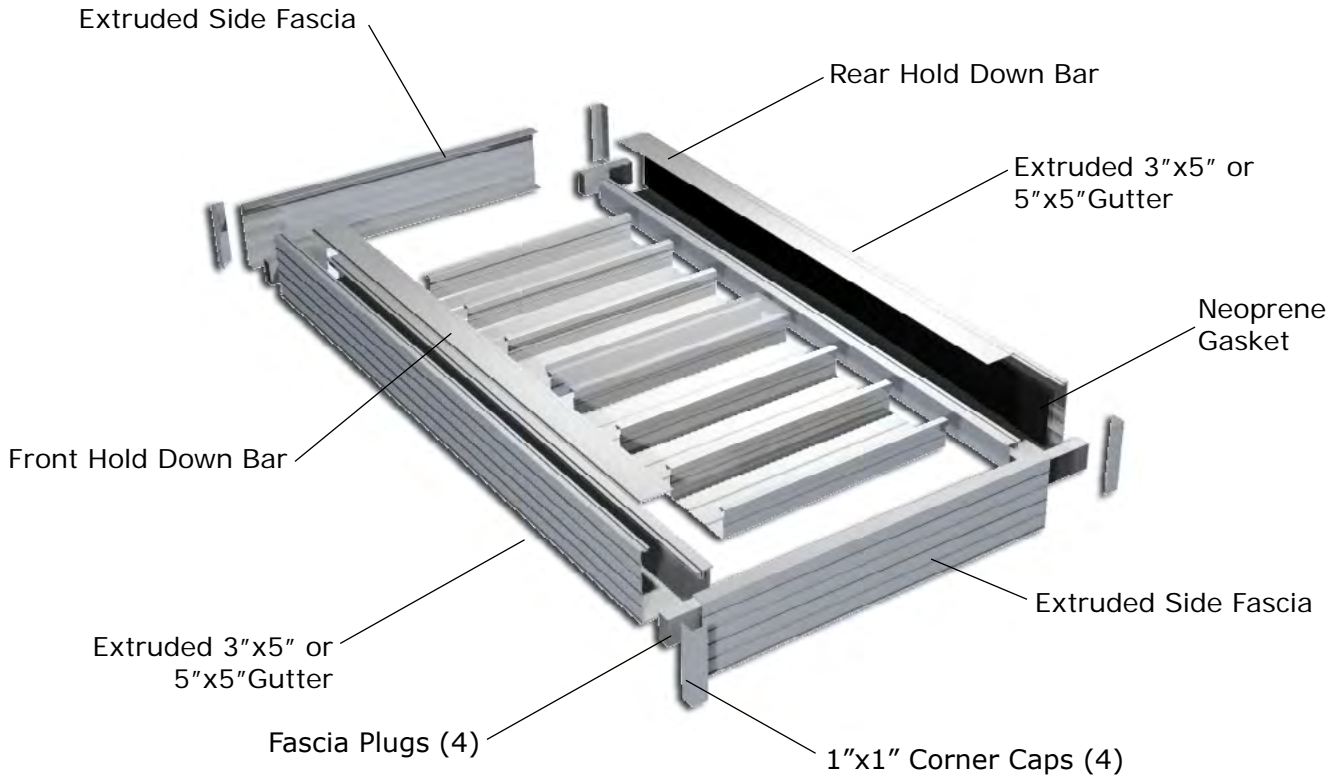

12" W Pan

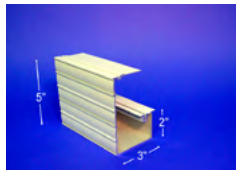

3"x5" Gutter

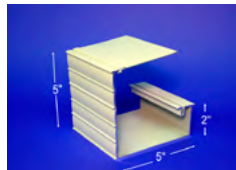

5"x5" Gutter

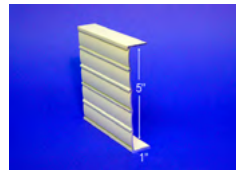

Side Fascia

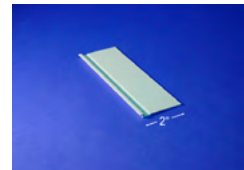

Hold Down Bar

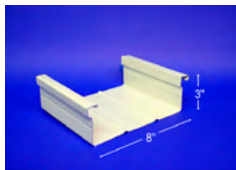

8" Flat Pan

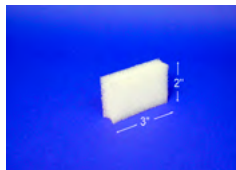

Fascia Plug

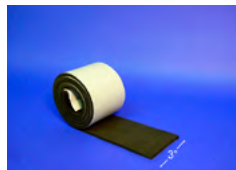

Neoprene Gasket

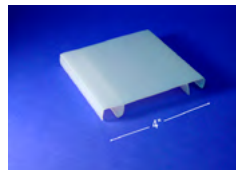

4" Skylites  
*\*Available option*





## 700 Ultra Series Extruded Square Foot Price List

### Gutter Front & Back Style

#### *Exclusive Ultra Series Features...*

- Patio cover kits have built-in gutter on front and back.
  - Massive 5"x5" Front gutter. .100" wall thickness. Makes cleaning out gutter a breeze & eliminates need for leaf guards.
  - Extra heavy extruded aluminum perimeter. Perfect for carports or walkway covers.
    - Drains from either front or back.
    - Neoprene gasket at rear eliminates call-backs.
  - No need to drill holes! All pans are pre-punched. Screw bosses in gutter.
    - Available Options: Skylites
  - Perimeter Colors: White, Brown, Bronze, Clay & Black
  - Pan Colors\*\*: White • Colonial White • Brown • Clay • Bronze • Black
- (\*\* Black, Bronze and Brown .024 only; Colonial White in .024 and .032 only)



700  
**ULTRA** series  
EXTRUDED PERIMETER

700 Ultra Series Extruded  
Square Foot Price List

# Gutter Front & Back Style

## Patio Cover Exploded Diagram

*Extruded Aluminum components make all the difference...*

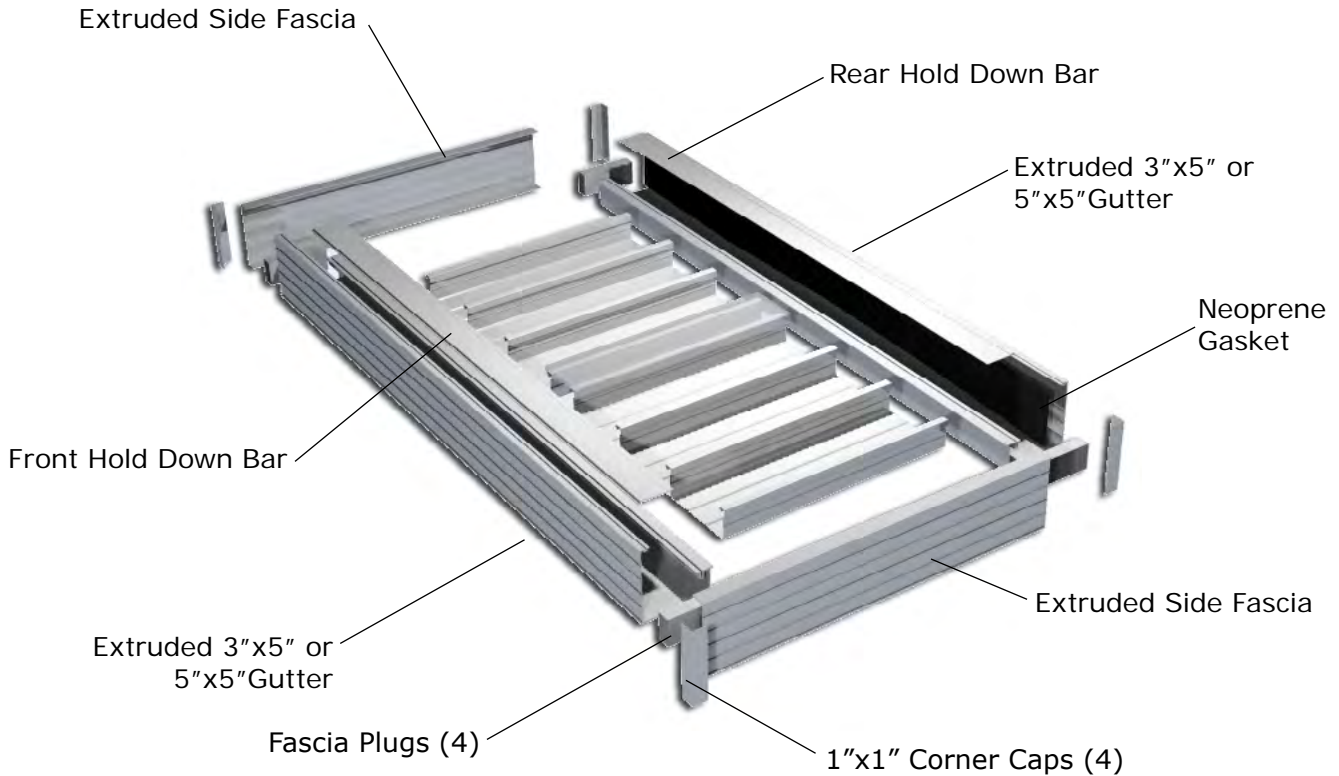

12" W Pan

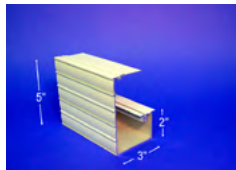

3"x5" Gutter

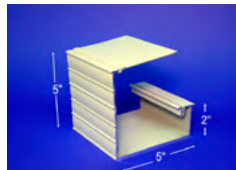

5"x5" Gutter

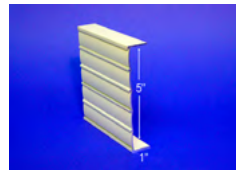

Side Fascia

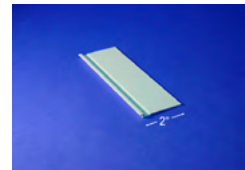

Hold Down Bar

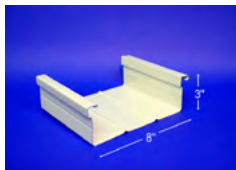

8" Flat Pan

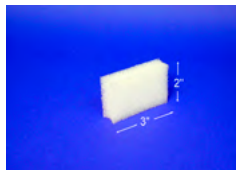

Fascia Plug

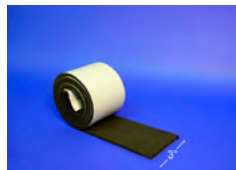

Neoprene Gasket

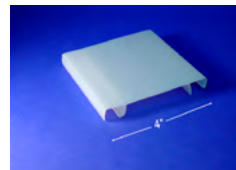

4" Skylites  
*\*Available option*

## 712 - 2"x2" Over Head Support Kit



Extruded 2"x2" square compression and tension struts are coupled with aluminum gusset plates and wall brackets allowing for a cover to be supported from above leaving total clearance below.

Catalog No	Item	Upper Arm Height
71203	3' Proj 2"x2" Over Head Support Kit	14"
71204	4' Proj 2"x2" Over Head Support Kit	20"
71205	5' Proj 2"x2" Over Head Support Kit	26"
71206	6' Proj 2"x2" Over Head Support Kit	32"
71207	7' Proj 2"x2" Over Head Support Kit	38"
71208	8' Proj 2"x2" Over Head Support Kit	44"
71209	9' Proj 2"x2" Over Head Support Kit	50"
71210	10' Proj 2"x2" Over Head Support Kit	56"

Projection	Tension Strut	Compression Strut
3'	26.25"	35"
4'	39.75"	47"
5'	53.25"	59"
6'	66.50"	71"
7'	80.25"	83"
8'	93.625"	95"

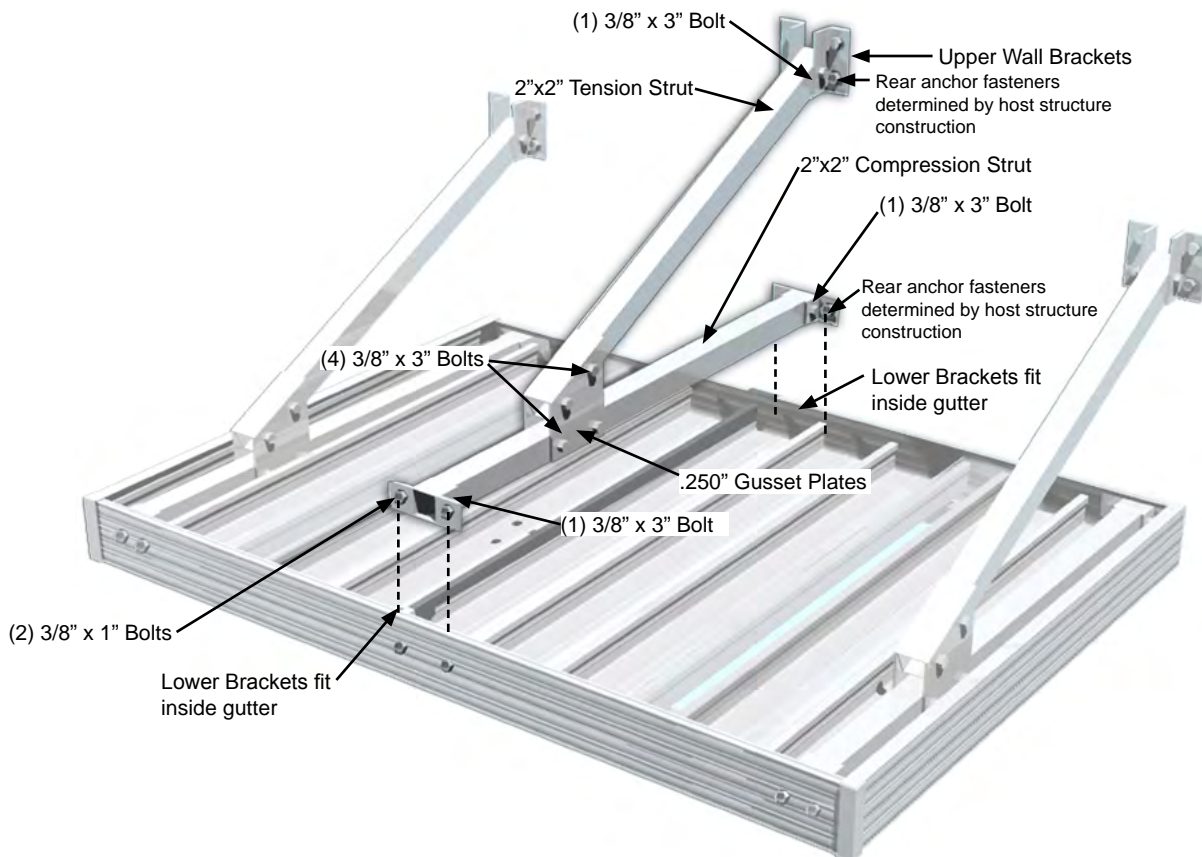

WALL HEIGHT REQUIRED  
 BOTTOM OF GUTTER TO  
 TOP OF TENSION STRUT  
 BRACKET

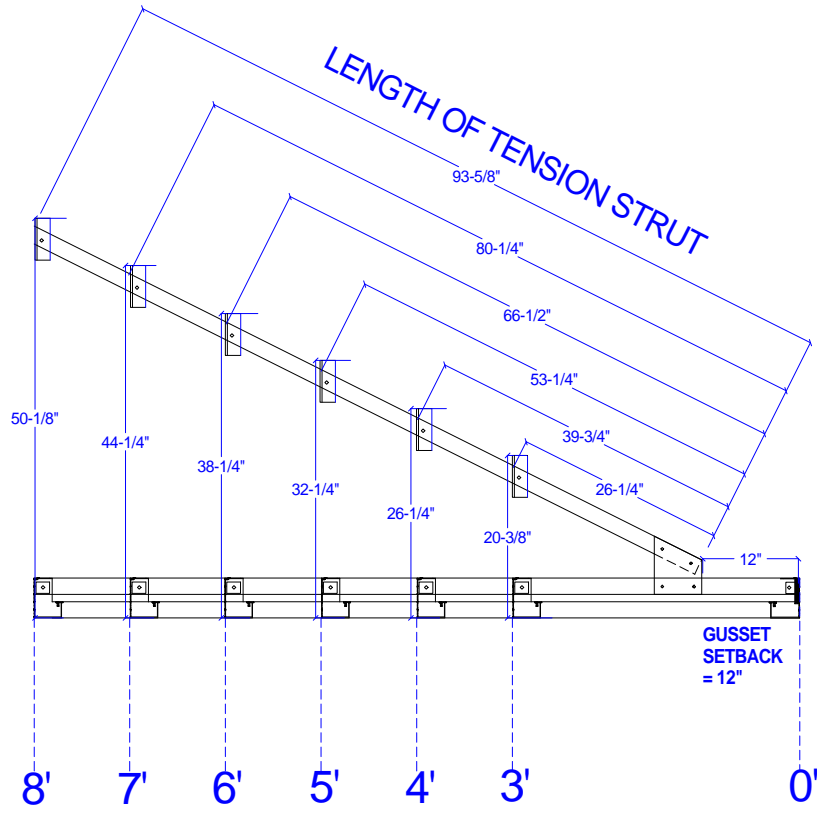

#712 OVERHEAD SUPPORT KIT COMPONENTS

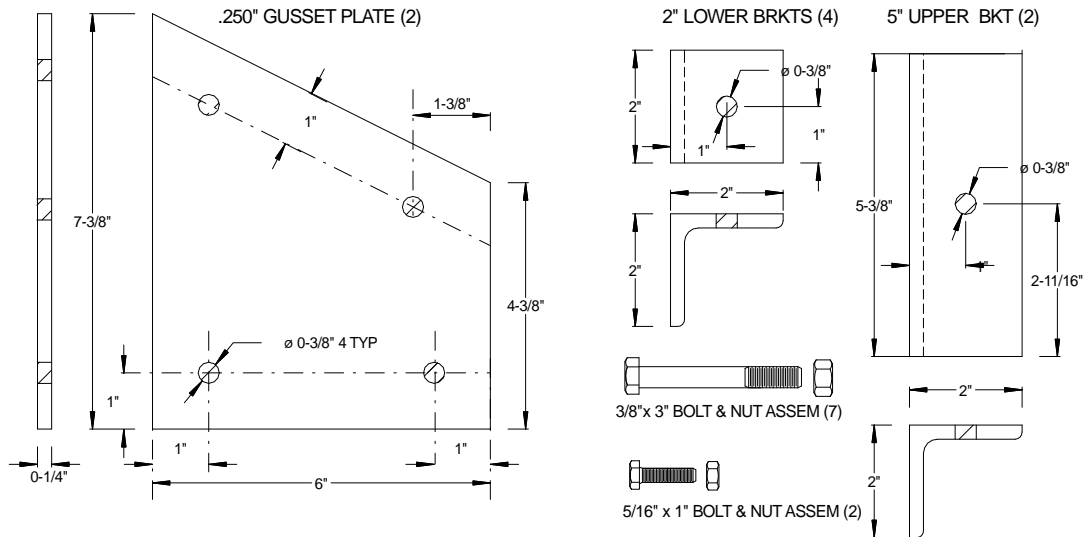



## *Suburb-A-Port*

### ROLL FORMED PERIMETER



### ***Patio Covers***

Stop blaming the weather and start making the most out of your free time with a Suburb-A-Port Series Patio, Deck, or Car Cover from Crest Aluminum. With several options customized to your specific needs, the Suburb-A-Port Series is the solution to all of your Patio, Deck & Car Cover needs. Featuring a quality baked-on enamel finish, your Suburb-A-Port is sure to provide you with many years of enjoyment and protection from the elements with little to no maintenance required.



### ***Deck Covers***

The Suburb-A-Port Series Patio, Deck, & Car Covers are offered with 2 different styles of roof panels, our 12" W Pans & our 8" Flat Pans. Both styles are offered in 3 different thicknesses and in 5 complimentary colors. The Suburb-A-Port Series is offered in 3 unique perimeter styles intended to be adaptable to most existing conditions. Heavy .050 aluminum is used to roll form all perimeter components. A full 3"x5" gutter is utilized for this system along with a 1"x5" side fascia.



### ***Commercial Canopies***

The Suburb-A-Port Series features an array of mounting options including a 2-piece hinged "G" Rail wall mounting system. This exclusive Crest "G" Rail system provides a strong and adjustable mounting point along with a built-in 3"x5" front gutter and 1"x5" side fascia. When the adjustable mounting rail is not required, the 3"x5" gutter is used either front and back or on all 4 sides. This allows for drainage at either end of the unit, an excellent choice for Carports & Walkway Covers.

All Suburb-A-Port Series covers include stainless steel fasteners for installation of roof panels & color matched fasteners for assembling the perimeter.

## "G" Hanging Rail Style

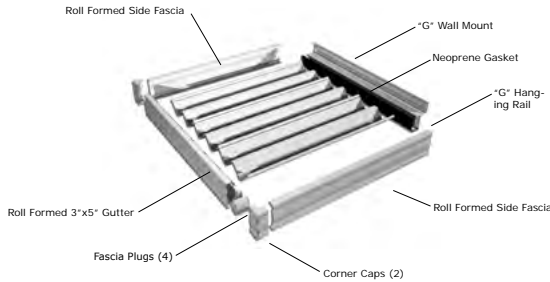

- Exclusive Crest Extruded Aluminum 2pc "G" Hanging Rail provides a strong "hinged" mounting system
- Heavy .050 Roll Formed Aluminum Side Fascias & Front Gutter
- Neoprene gasket inside of mounting rail prevents pans from leaking along mounting rail eliminating call backs
- Optional 4" skylite panels are available upon request

## Gutter Front & Back Style

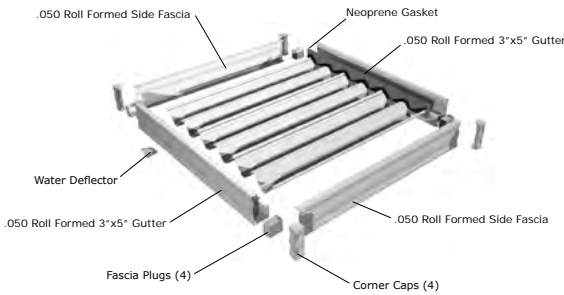

- .050 thick Roll Formed Gutter on front & back with 1" x 5" fascia capping the ends for a clean look.
- 4 Corner caps & 2 rain deflectors standard.
- Cover can be drained at front or back
- Neoprene gasket and gutter end plugs included.
- Optional 4" skylite panels are available upon request
- Commonly used as a Commercial Canopy where spouting will be run along the building wall.

## Full Perimeter Style

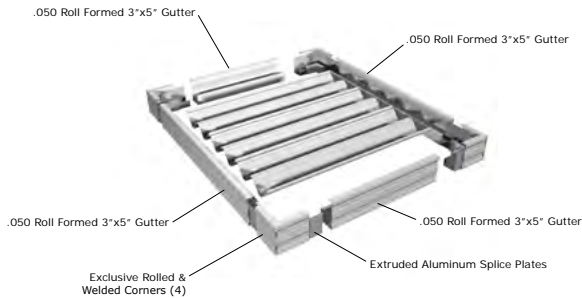

- .050 thick Roll Formed 3"x5" Gutter on all 4 sides.
- Heavy .050 Roll Formed Aluminum Gutter with Exclusive Crest Mitred and Welded Corners for extreme strength and a "seamless" look.
- Allows for drainage at the front or back of the unit
- An excellent choice for Car Ports, Walkway, & Dock Covers.
- Optional 4" skylite panels are available upon request

## Available Colors

Perimeter						
	Polar White	Colonial White				
.024 Flat & W Pans						
	Polar White	Colonial White	Sierra Clay	Chestnut Brown	Quaker Bronze	Black
.032 Flat & W Pans						
	Polar White	Colonial White				
.040 Flat & W Pans						
	Polar White	Colonial White	Sierra Clay			

Suburb-A-Port Series  
Square Foot Price List**"G" Hanging Rail Style*****Exclusive "G" Rail Suburb-A-Port Series Features....***

- Extruded Aluminum 2 pc "G" Hanging Rail Suburb-A-Port kits have built-in 3"x5" gutter on front.
    - Heavy .050 Roll Formed Aluminum 1"x5" Side Fascias and Front Gutter.
  - Exclusive Crest "G Rail" mounting system provides a strong and adjustable mounting point.
    - Neoprene gasket at rear eliminates call-backs.
    - Available in 3 Roof Gauges and 2 Pan Styles
    - Perimeter Colors: White and Colonial White
    - Pan Colors\*\*: White • Colonial White • Brown • Clay • Bronze • Black
- (\*\* Black, Bronze and Brown .024 only; Colonial White in .024 and .032 only)

*Suburb-A-Port*  
ROLL FORMED PERIMETER

Suburb-A-Port Series  
Square Foot Price List

"G" Hanging Rail Style  
Patio Cover Exploded Diagram

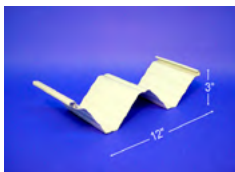
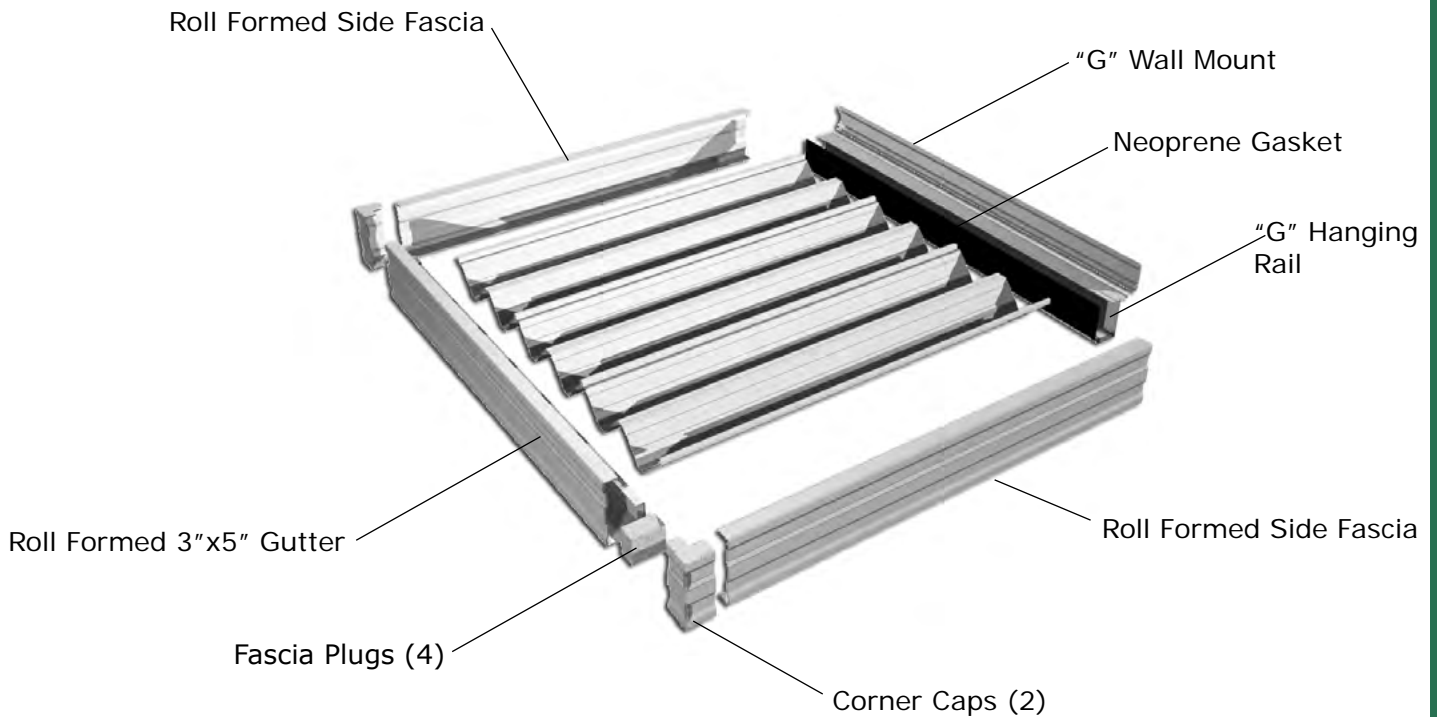

12" W Pan

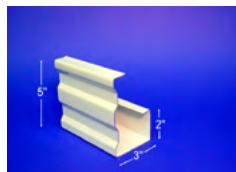

3"x5" Gutter

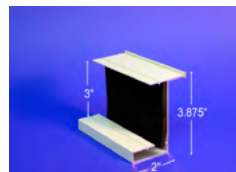

"G" Hanging Rail

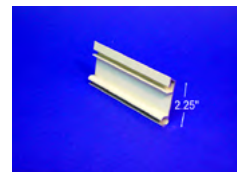

"G" Wall Mount

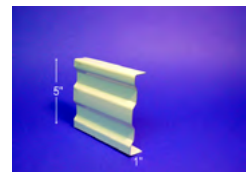

Side Fascia

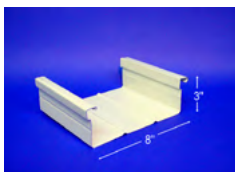

8" Flat Pan

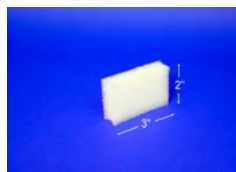

Fascia Plug

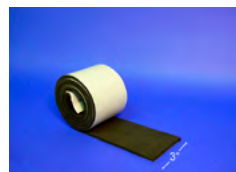

Neoprene Gasket



Corner Cap

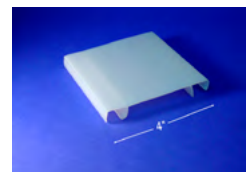

4" Skylites  
*\*Available option*



Suburb-A-Port Series  
Square Foot Price List

## Full Perimeter Style

*Exclusive Suburb-A-Port Series Features....*

- Suburb-A-Port "Full Perimeter" kits have built-in 3"x5" gutter on all 4 sides.
    - Exclusive Crest Rolled & Welded Corners for a "Seamless" look.
      - Excellent choice for Car-Ports or Dock Covers
      - Allows water drainage front or back of unit.
    - Heavy .050 Roll Formed Aluminum Gutter Sections.
      - Available in 3 Roof Gauges and 2 Pan Styles.
      - Perimeter Colors: White and Colonial White
    - Pan Colors\*\* : White • Colonial White • Brown • Clay • Bronze • Black
- (\*\* Black, Bronze and Brown .024 only; Colonial White in .024 and .032 only)



Suburb-A-Port Series  
Square Foot Price List

**Full Perimeter Style**  
Patio Cover Exploded Diagram

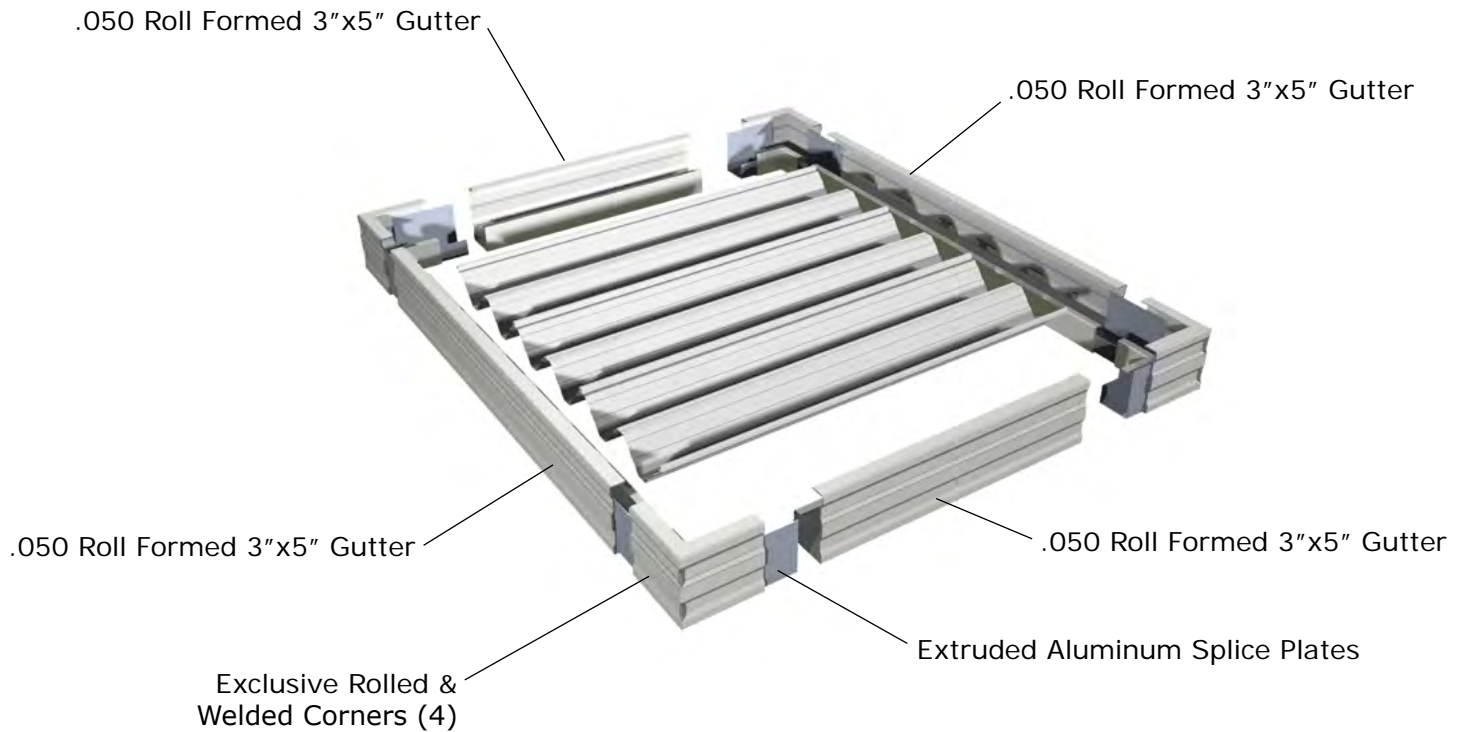

12" W Pan

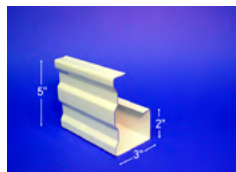

3"x5" Gutter

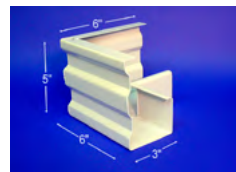

Welded Corner

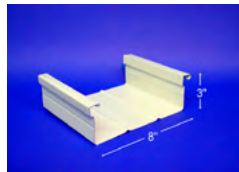

8" Flat Pan

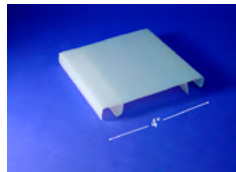

4" Skylites  
*\*Available option*

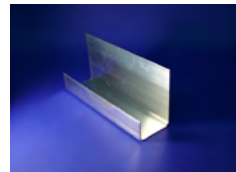

Gutter/Corner  
Splice

Suburb-A-Port Series  
Square Foot Price List**Gutter Front & Back Style***Exclusive Suburb-A-Port Series Features....*

- Roll Formed Gutter Front & Back kits have heavy .050 3"x5" gutter on front & back.
  - .050 Roll Formed 1"x5" side fascias.
  - 4 Corner Caps - 2 Rain Deflectors
- Stainless fasteners for pans - Painted fasteners for perimeter.
  - Available in 3 Roof Gauges and 2 Pan Styles.
  - Perimeter Colors: White and Colonial White
- Pan Colors\*\* : White • Colonial White • Brown • Clay • Bronze • Black  
(\* \*\* Black, Bronze and Brown .024 only; Colonial White in .024 and .032 only)



Suburb-A-Port Series  
Square Foot Price List

# Gutter Front & Back Style

## Patio Cover Exploded Diagram

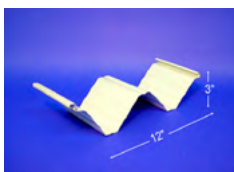
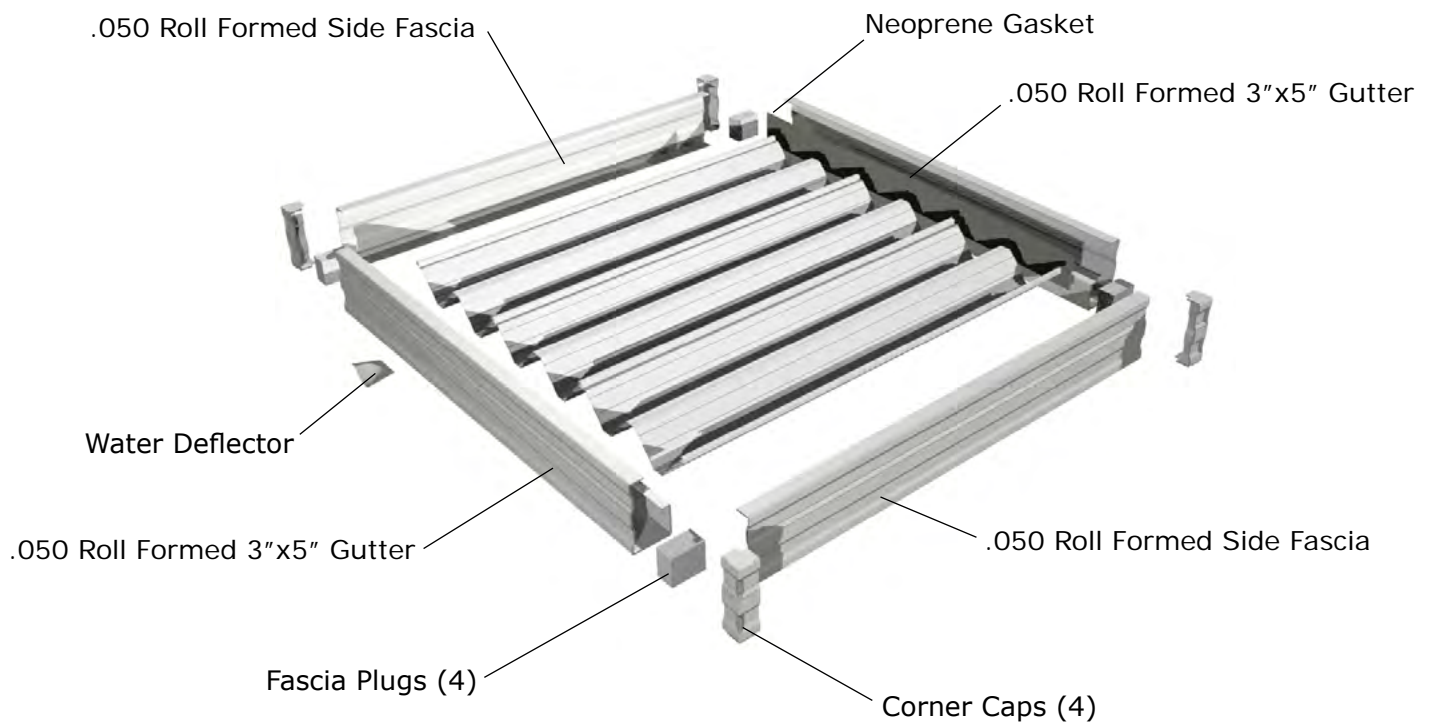

12" W Pan

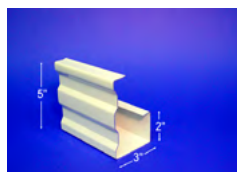

3"x5" Gutter

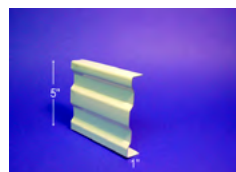

Side Fascia



Corner Cap

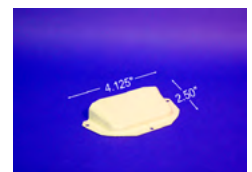

Water Deflector

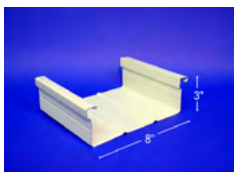

8" Flat Pan

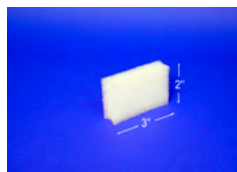

Fascia Plug



Neoprene Gasket

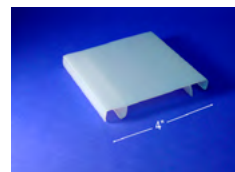

4" Skylites  
*\*Available option*



Width	Skylites	Flat Pans
8' 8"	2	12
9' 4"	2	13
10' 0"	2	14
10' 8"	4	14
11' 4"	4	15
12' 0"	4	16
12' 8"	4	17
13' 4"	4	18
14' 0"	4	19
14' 8"	4	20
15' 4"	4	21
16' 0"	6	21
16' 8"	6	22
17' 4"	6	23
18' 0"	6	24
18' 8"	6	25
19' 4"	6	26
20' 0"	6	27
20' 8"	8	27
21' 4"	8	28
22' 0"	8	29
22' 8"	8	30
23' 4"	8	31
24' 0"	8	32
24' 8"	8	33
25' 4"	10	33
26' 0"	10	34
26' 8"	10	35
27' 4"	10	36
28' 0"	10	37
28' 8"	10	38
29' 4"	10	39
30' 0"	12	39
30' 8"	12	40
31' 4"	12	41
32' 0"	12	42
32' 8"	12	43
33' 4"	12	44
34' 0"	12	45
34' 8"	14	45
35' 4"	14	46
36' 0"	14	47
36' 8"	14	48
37' 4"	14	49
38' 0"	14	50
38' 8"	14	51
39' 4"	16	51
40' 0"	16	52
40' 8"	16	53
41' 4"	16	54
42' 0"	16	55
42' 8"	16	56
43' 4"	16	57
44' 0"	18	57

Key: Flat Pan Skylite

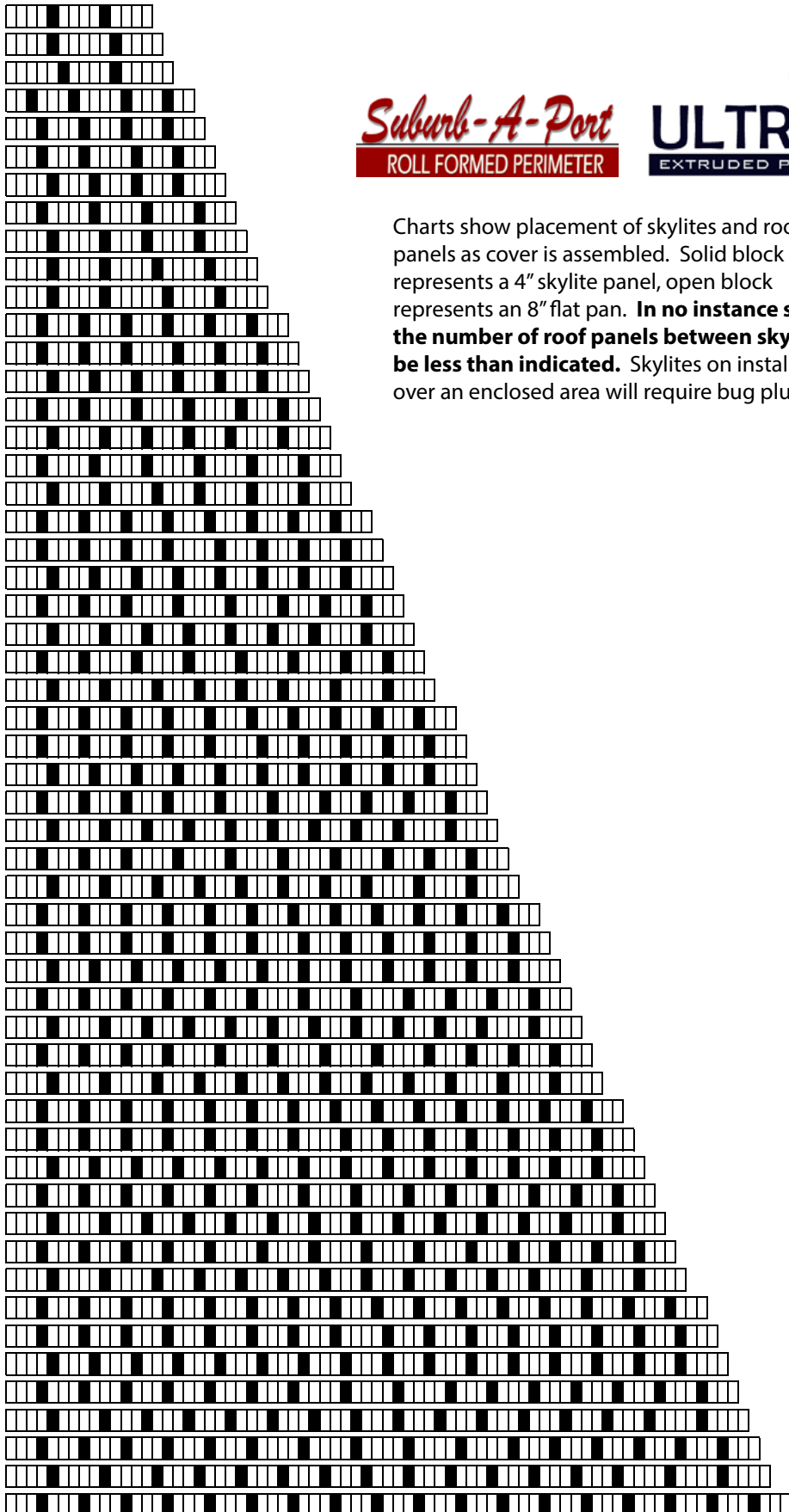

*Suburb-A-Port*  
ROLL FORMED PERIMETER

700  
**ULTRA** series  
EXTRUDED PERIMETER

Charts show placement of skylites and roof panels as cover is assembled. Solid block represents a 4" skylite panel, open block represents an 8" flat pan. **In no instance should the number of roof panels between skylites be less than indicated.** Skylites on installations over an enclosed area will require bug plugs.



# Pre-Cut Patio Cover Order Sheet

Order Date: \_\_\_\_\_ Required Date: \_\_\_\_\_ Job Name/PO#: \_\_\_\_\_

Dealer Name: \_\_\_\_\_ Phone: (\_\_\_\_) \_\_\_\_\_ Ship To: \_\_\_\_\_

**1) SIZE OF COVER:**  
 Projection= \_\_\_\_\_ Width= \_\_\_\_\_

Office Use Only

**2) TYPE OF PANS:**

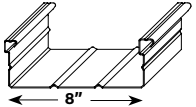
8" FLAT PAN 

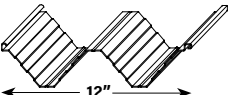
12" W PAN 

**3) GAUGE & COLOR OF PANS:**

COLOR	GAUGE: 024	032	040	PAN COLOR IS ON: <b>TOP</b> <b>BOTTOM</b> Circle one
	WHITE	WHITE	WHITE	
COL WHITE	COL WHITE	COL WHITE	CLAY	
BROWN			MATTE BLACK	
BLACK				
BRONZE				
BRZ IS BOTH SIDES		ALL OTHER COLORS HAVE WHITE ON BACK		

**4) SKYLITES:** YES \_\_\_\_\_ NO \_\_\_\_\_  TRANSLUCENT WHITE ONLY

**5) PERIMETER STYLE:**  EXTRUDED ULTRA 700 SERIES

**EXTRUDED PERIMETER: COLOR & STYLE**

5a) **COLOR**  WHT  BRN  BRZ  CLAY  BLACK

5b) **STYLE**  EXT "J" HANGING RAIL  
 EXT GUTTER FRONT & BACK  
 EXT GUTTER ALL 4 SIDES (3X5 GUTTER ONLY)

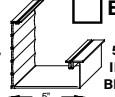
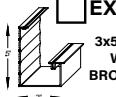
5c) **GUTTER**  EXT 5X5   EXT 3X5   
 5x5 AVAILABLE IN WHITE, CLAY BROWN & BLACK  
 3x5 AVAILABLE IN WHITE, CLAY, BROWN, BRONZE & BLACK

**5) PERIMETER STYLE:**  ROLL FORMED Suburb-A-Port Series

**ROLL FORMED PERIMETER: COLOR & STYLE**

5a) **COLOR**  WHT  COLONIAL WHITE

5b) **STYLE**  RF "G" HANGING RAIL  
 RF GUTTER FRONT & BACK  
 RF GUTTER ALL 4 SIDES

 Suburb-A-Port ROLL FORMED COVERS OFFERED IN .050 3"x5" GUTTER ONLY

**6) BEAMS - POSTS - SPOUTS**

BEAMS	SIZE	QTY	COLOR	POSTS	SIZE	QTY	COLOR
3x4 "I" BEAM				3" FLUTED POST			
3x7 "I" BEAM				3" SMOOTH .090 POST			
2 1/2" x 10" "C" BEAM				3" 11 GAUGE STEEL			
1 1/2" SETBACK BEAM				2" SQUARE ALUMINUM			
2" SETBACK BEAM				1 1/2" SQUARE ALUMINUM			
3" SETBACK BEAM				1 1/2" FLAT COLUMN			
SPOUT KIT				1 1/2" CORNER COLUMN			
OTHER				POST BASES			

**SPECIAL INSTRUCTIONS:**

**FAX 800-255-1583 or EMAIL orders@crestaluminum.com**

Covers & Canopies

## THE BEST LOOKING AWNING IN THE NEIGHBORHOOD

# Canvalum®700 Canopy™

U.S. PATENT NOs 6,848,222; D504,956 S;  
D513, 804 S; 7,065,934B2  
CANADIAN PATENT NO 2,424,413

Covers & Canopies



If you are considering a roll-up or fabric awning purchase... you should take a look at the New **Canvalum®** Canopy from Crest



Aluminum. We have taken our best 4 Season Cover and adorned it with beautiful Sunbrella® fabric offering the discriminating homeowner the beauty of fabric with four season protection. **Canvalum®** Canopies look like traditional fabric awnings but are designed to shelter against rain, high winds and direct sun all year round. The bright, smooth and easy to keep clean understructure is designed for loads of up to 50 lbs per square foot for unparalleled year-round performance. Optional sky-lite panels are also available to provide gently filtered light.

**FINALLY...**  
**The beauty of  
canvas all year  
round"**



- *No need to roll it up when it rains or gets windy!*
- *No yearly installation charges!*
- *The look of fabric with the strength of aluminum!*
- *Available in over 100 beautiful stripe and solid color combinations!*

**NOW YOU CAN HAVE  
A FOUR SEASON  
FABRIC AWNING  
THAT LOOKS GREAT**

***So unique... IT IS PATENTED!***



8287 Tyler Blvd  
Mentor, Ohio 44060 USA  
ph 800-255-1588  
fax 800-255-1583  
www.crestaluminum.com

"Canvalum® The Best Looking and Most Functional Awning in the World"

# Canvalum® CANOPY

US Patent Nos 6,848,222; D504,956 S; D513,804 S; 7,065,934 B2; Canadian Patent No 2,424,413

## ORDER FORM

ORDER DATE: \_\_\_\_\_ REQ'D: \_\_\_\_\_ SO # \_\_\_\_\_

COMPANY NAME: \_\_\_\_\_ JOB NAME/PO # \_\_\_\_\_

*Please fill in all spaces, we can not process incomplete forms. Thank You*

1) FABRIC STYLE: \_\_\_\_\_ (Sunbrella Fabric # & Description)

2) LENGTH: \_\_\_\_\_

3) VALANCE STYLE: \_\_\_\_\_ (please circle one below)



4) BINDING COLOR: \_\_\_\_\_ (please circle one below)

Natural      Tan      Burgundy      Forest Green      Best Match

5) AWNING PERIMETER COLOR: (Velcro® hold down tabs will match - please circle one below)

White      Clay      Brown      Bronze      Almond

6) AWNING PERIMETER FASCIA HEIGHT: \_\_\_\_\_ (For Velcro® Tabs location)

Where possible, Velcro® hold down tabs are located on the bottom side of side fascias and gutters. In some cases this is not possible, as in many insulated roof perimeter styles where the side fascia has a very small area to attach to. We will make a determination that best suits the style of perimeter you are working with.

### KEVLAR® CORNER REINFORCEMENT LOCATIONS

#### NOTES:

PLEASE INDICATE ALL DIMENSIONS OF COVER  
FRONT OVERALL WIDTH AND EACH SIDE FROM FRONT CORNER TO  
HOUSE. PLEASE BE PRECISE.

- 1) KEVLAR® CORNER PROTECTORS WILL BE SEWN IN AT EACH CORNER TO PREVENT ABRASION OF THE FABRIC.
- 2) ENDS WILL BE FINISHED (HEMMED AND SEWN)
- 3) VELCRO® HOLD DOWN TABS WILL BE SEWN IN AT 60" SPACING TO PREVENT FABRIC FROM BLOWING UP ONTO CANOPY. HOOK TAB IS FASTENED TO BOTTOM EDGE OF SIDE FASCIA AND GUTTER FASCIA UTILIZING ADHESIVE BACKER.

HOUSE WALL

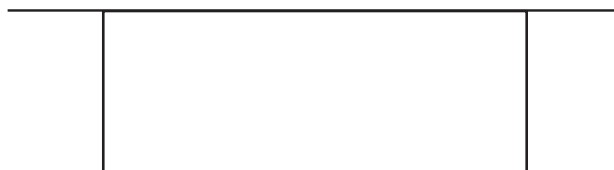



# Posts & Beams

**Posts & Beams**  
**Posts, Columns, Base Plates, & Structural Beams**



Photo courtesy of Chuck's Aluminum - Ohio

## 732 - 1½" 2pc Setback Beam

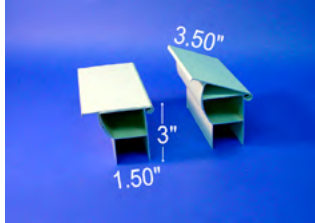

An extruded aluminum 2 pc. setback beam that adjust to the pitch of the awning. 1 1/2" posts fit inside bottom of beam.

Catalog No	Item	Length	Pcs / Ctn	Colors
73210	1½" 2pc Setback Beam	10'	1	White
73212	1½" 2pc Setback Beam	12'	1	White
73214	1½" 2pc Setback Beam	14'	1	White
73220	1½" 2pc Setback Beam	20'	1	White
73224	1½" 2pc Setback Beam	24'	1	White

## 733 - 2" 2pc Setback Beam

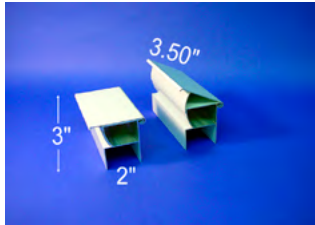

An extruded aluminum 2 pc. setback beam that adjust to the pitch of the awning. 2" posts fit inside bottom of beam. The beams are also used with 2" screen rooms.

Catalog No	Item	Length	Pcs / Ctn	Colors
73310	2" 2pc Setback Beam	10'	1	White
73312	2" 2pc Setback Beam	12'	1	White
73314	2" 2pc Setback Beam	14'	1	White
73320	2" 2pc Setback Beam	20'	1	White
73324	2" 2pc Setback Beam	24'	1	White

## 733A - 3" 2pc Setback Beam

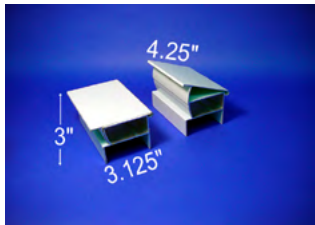

An extruded aluminum 2 pc. setback beam that adjust to the pitch of the awning. 3" posts fit inside bottom of beam. The beams are also used with 3" insulated rooms.

Catalog No	Item	Length	Pcs / Ctn	Colors
733A10	3" 2pc Setback Beam	10'	1	White
733A12	3" 2pc Setback Beam	12'	1	White
733A14	3" 2pc Setback Beam	14'	1	White
733A20	3" 2pc Setback Beam	20'	1	White
733A24	3" 2pc Setback Beam	24'	1	White, Clay

## 734 - 3"x4" Aluminum I Beam

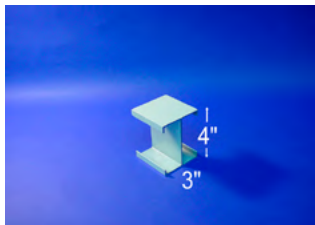

An extruded aluminum I beam. 3" wide x 4" tall Heavy .095 wall thickness. Full strength splice available

Catalog No	Item	Length	Pcs / Ctn	Colors
73410	3"x4" Aluminum I Beam	10'	1	White
73412	3"x4" Aluminum I Beam	12'	1	White
73414	3"x4" Aluminum I Beam	14'	1	White
73420	3"x4" Aluminum I Beam	20'	1	White
73424	3"x4" Aluminum I Beam	24'	1	White
SPLICE	Splice Kit for 3"x4" Aluminum I Beam	20"	1	White

## 735 - 3"x7" Aluminum I Beam



An extruded aluminum I beam. 3" wide x 7" tall Heavy .095 wall thickness. Full strength splice available

Catalog No	Item	Length	Pcs / Ctn	Colors
73510	3"x7" Aluminum I Beam	10'	1	White
73512	3"x7" Aluminum I Beam	12'	1	White
73514	3"x7" Aluminum I Beam	14'	1	White
73520	3"x7" Aluminum I Beam	20'	1	White
73524	3"x7" Aluminum I Beam	24'	1	White, Clay, Bronze
SPLICE-FS-7	Splice Kit for 3"x7" Aluminum I Beam	30"	1	White

## 730 - 2.5"x10" Aluminum C Beam

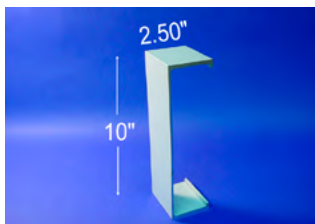

A heavy extruded aluminum C beam. .125" wall thickness, can be used as a single section or bolted "back to back" to form a strong "I" beam section. Full strength splice available.

Catalog No	Item	Length	Pcs / Ctn	Colors
73010	2.5"x10" Aluminum C Beam	10'	1	White
73012	2.5"x10" Aluminum C Beam	12'	1	White
73014	2.5"x10" Aluminum C Beam	14'	1	White
73020	2.5"x10" Aluminum C Beam	20'	1	White
73024	2.5"x10" Aluminum C Beam	24'	1	White, Clay, Bronze
SPLICE-FS	Splice Kit for 10" Aluminum C Beam	40"	1	White

### 75-TILT - 2"x4" .055 Tilt Beam

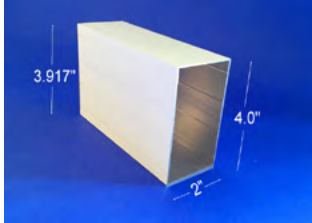

An extruded aluminum support beam 2" wide and 4" tall with a sloped top to accommodate a 1/2" per foot pitch.

Catalog No	Item	Length	Wall Thickness
75-BEAM-2X4TILT	2"x4" .055 Tilt Beam	24'	.055"
Available in White, Almond, & Bronze.			

### 75-CARRY - 2"x5" Elite Carry Beam

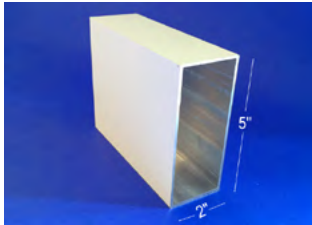

An extruded aluminum support beam 2" wide and 5" tall with .093" thick walls.

Catalog No	Item	Length	Wall Thickness
75-BEAM	2"x5" Elite Carry Beam	24'	.093"
Available in White, Black, Almond, & Bronze.			

### 75-BEAM2PC - 2" 2pc Lap Beam

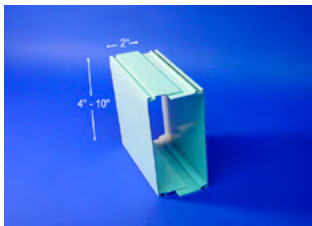

A 2 piece extruded aluminum 2" wide support beam. Available in various heights to accommodate various spans. Available in white & bronze.

Catalog No	Item	Length	Wall Thickness
75-BEAM2PC-4	2"x4" 2pc Lap Beam	24'	.045"
75-BEAM2PC-6	2"x6" 2pc Lap Beam	24'	.050"
75-BEAM2PC-7	2"x7" 2pc Lap Beam	24'	.057"
75-BEAM2PC-8	2"x8" 2pc Lap Beam	24'	.072"
75-BEAM2PC-9	2"x9" 2pc Lap Beam	24'	.072"

### 75-BEAM - Elite 2000 2.625" Carry Beam

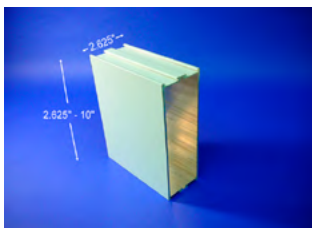

Beam can be used a carry beam or as a support column. This beam incorporates a system of concealed connectors and fasteners for a clean finish.

Catalog No	Item	Length	Wall Thickness
75-BEAM-2X2	2.625"x2.625" Elite 2000 Carry Beam	24'	.078"
75-BEAM-2X4	2.625"x4" Elite 2000 Carry Beam	24'	.078"
75-BEAM-2X6	2.625"x6" Elite 2000 Carry Beam	24'	.078"
75-BEAM-2X8	2.625"x8" Elite 2000 Carry Beam	24'	.125"
75-BEAM-2X10	2.625"x10" Elite 2000 Carry Beam	24'	.125"
Available in White, Almond, & Bronze.			

### 75-CONN - Connector for Elite 2000 Beam

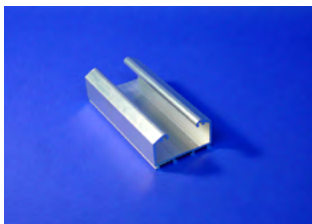

An extruded aluminum concealed connecting bracket used with the Elite 2000 beams.

Catalog No	Item	Length
75-CONN-2X2	2.625" Elite 2000 Carry Beam Connector	-
75-CONN-2X4	4" Elite 2000 Carry Beam Connector	-
75-CONN-2X6	6" Elite 2000 Carry Beam Connector	-
75-CONN-2X8	8" Elite 2000 Carry Beam Connector	-
75-CONN-2X10	10" Elite 2000 Carry Beam Connector	-
Available in Mill Finish only		

### 75-TRIM - Snap Trim for Elite 2000 Beams

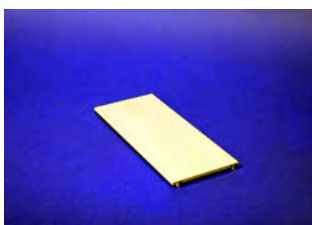

Trim snaps into tracks on Elite 2000 beams to conceal fastener heads. Available either Flat or Sloped. Sloped adapter accommodates a 1/2" per foot slope.

Catalog No	Item	Length	Pcs / Ctn
75-FLAT-TRIM	Flat Snap Trim for Elite 2000 Beams	24'	1
75-SLOPE	Slope Adapter for Elite 2000 Beams	24'	1
Available in White, Almond, & Bronze.			



## 205 - 1" Square Extruded Tube

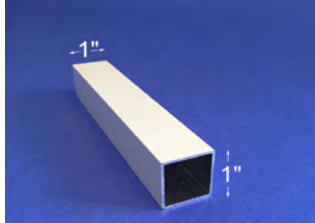

.055" wall extruded aluminum tube used for making 1" flat and corner scroll columns.

Catalog No	Item	Length	Pcs / Ctn	Wall Thickness
20510	1" Square Extruded Tube	10'	25	.055"
20516	1" Square Extruded Tube	16'	25	.055"

Available in White & Black

## 201 - 1½" Square Extruded Tube

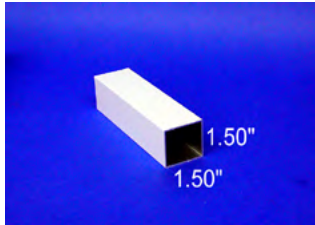

.055" wall extruded aluminum tube used for making 1½" flat and corner scroll columns.

Catalog No	Item	Length	Pcs / Ctn	Wall Thickness
20108	1½" Square Extruded Tube	8'	16	.055"
20110	1½" Square Extruded Tube	10'	16	.055"
20116	1½" Square Extruded Tube	16'	16	.055"
20120*	1½" Square Extruded Tube	20'	16	.055"

Available in White, Black, Brown, & Clay. \*White or Black only

## 222 - 2"x2" Square .062 Aluminum Post

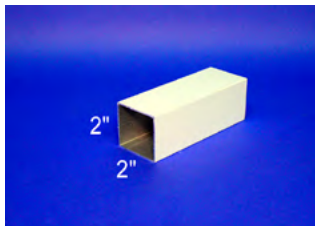

.062" wall extruded square aluminum used mostly for single post applications. Commonly used with the #617 flange.

Catalog No	Item	Length	Pcs / Ctn	Wall Thickness
22208	2"x2" Square .062 Aluminum Post	8'	9	.062"
22210	2"x2" Square .062 Aluminum Post	10'	9	.062"
22216	2"x2" Square .062 Aluminum Post	16'	9	.062"
22224*	2"x2" Square .062 Aluminum Post	24'	9	.062"

Available in White, Almond, Black, Brown, Bronze, & Clay. \*24' available in White, Black & Almond only

## 220 - 3"x3" Fluted Aluminum Post

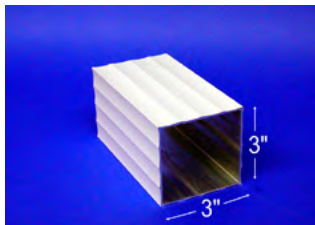

.080" wall extruded aluminum tube with "flutes" makes a strong single support post. Used commonly with the #219 flange.

Catalog No	Item	Length	Pcs / Ctn	Wall Thickness
22008	3"x3" Fluted Aluminum Post	8'	6	.080"
22010	3"x3" Fluted Aluminum Post	10'	6	.080"
22012	3"x3" Fluted Aluminum Post	12'	6	.080"
22016	3"x3" Fluted Aluminum Post	16'	6	.080"
22020	3"x3" Fluted Aluminum Post	20'	6	.080"
22024	3"x3" Fluted Aluminum Post	24'	6	.080"

Available in White, Almond, Black, Brown, Bronze, Clay, Canyon Red, & Hunter Green.

## 220A - 3"x3" Smooth .093" Aluminum Post

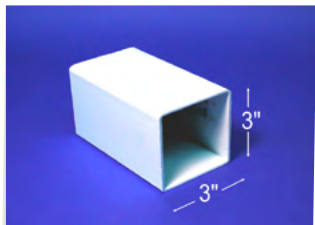

3" square extruded .093" wall, smooth aluminum post provides additional strength along with a more contemporary look.

Catalog No	Item	Length	Pcs / Ctn	Wall Thickness
220A24	3"x3" .093 Smooth Post	24'	1	.093"

## 650-653 - 1" & 1½" Extruded Flat & Corner Scroll Columns

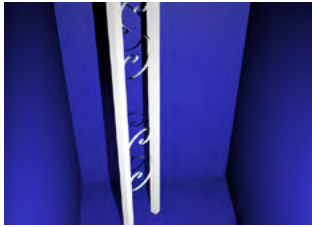

(2) 1" or 1½" extruded posts assembled with #204 standard post scrolls to create a strong flat column. Bases are sold separately.

Catalog No	Item	Length	# scrolls
65008, 65010	1" Extruded Tube Flat Scroll Column	8' / 10'	3 / 4
65208, 65210	1½" Extruded Tube Flat Scroll Column	8' / 10'	3 / 4
65108, 65110	1" Extruded Tube Corner Scroll Column	8' / 10'	6 / 8
65308, 65310	1½" Extruded Tube Corner Scroll Column	8' / 10'	6 / 8

#650 Available in White or Black / #652 available in White, Black, Brown, & Clay.

## 204 - Standard Post Scroll



Extruded aluminum pre-punched single "S" column scroll. 20" long x 6" wide. Extruded scrolls are made with 0.125" thick & 0.50" wide extruded aluminum scroll stock

Catalog No	Item	Length	Pcs / Ctn
20400	Standard Post Scroll	6"x20"	50

Available in White, Brown, Black, & Clay.

## 206 - Deluxe Post Scroll

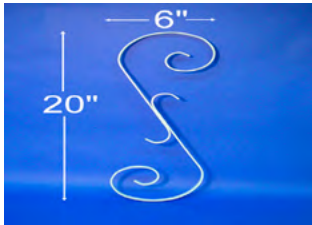

Extruded aluminum pre-punched double "S" column scroll. 20" long x 6" wide. Extruded scrolls are made with 0.125" thick & 0.50" wide extruded aluminum scroll stock

Catalog No	Item	Length	Pcs / Ctn	Wall Thickness
20600	Deluxe Post Scroll	6"x20"	50	.125"

Available in White, Brown, Black, & Clay.

## 204H - Heart Post Scroll

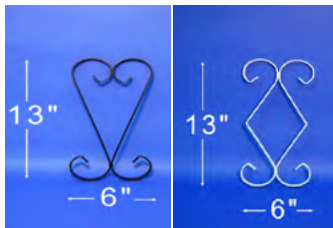

Extruded aluminum pre-punched "heart" or "diamond" shaped column scroll. 20" long x 6" wide. Extruded scrolls are made with 0.125" thick & 0.50" wide extruded aluminum scroll

Catalog No	Item	Length	Pcs / Ctn	Wall Thickness
204H00	Heart Post Scroll	6"x13"	50	.125"
204D00	Diamond Post Scroll	6"x13"	50	.125"

Available in White, Brown, Black, & Clay.

## 204R01 - Roll Formed Scroll



Roll Formed Scroll used in scroll columns. 4 holes are pre-punched. Roll formed scrolls are made with .024 aluminum 1" wide roll formed scroll pins.

Catalog No	Item	Length	Pcs / Ctn	Wall Thickness
204R01	Roll Formed Scroll	5"x16"	50	.024"

Available in White, Brown, Black, & Clay.

## 204R - Roll Formed Scroll Pin



42" Roll Formed Scroll "Pin". Straight "pins" are 1" wide and are bent into "S"-shaped scrolls to be used in scroll columns. 4 holes are pre-punched. Available without holes and in special lengths, by special order.

Catalog No	Item	Length	Pcs / Ctn	Wall Thickness
204R00	Roll Formed Scroll Pin	42"	200	.024"

Available in White, Brown, Black, & Clay.

## 615 - 1" - 1½" Long Stem Floor Plate

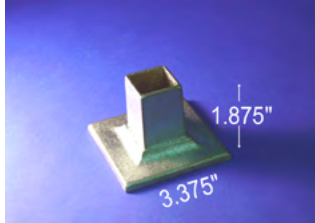

Cast aluminum flange. 1" tube fits inside, 1 1/2" tube fits outside. For single post applications.

Catalog No	Item	Length	Pcs / Ctn	Color
61500	1" - 1½" Long Stem Floor Plate	3.375" x 1.875"	25	Mill Finish

## 619 - 1½" Single Post Flange Casting w/ Tabs

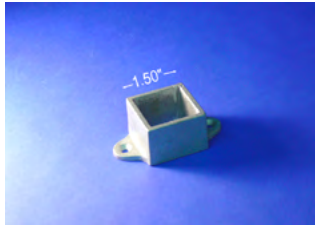

Cast aluminum flange. 1 1/2" post fits inside flange.

Catalog No	Item	Length	Pcs / Ctn	Color
61900	1½" Single Post Flange Casting w/ Tabs	1.50" x 1.50"	25	Mill Finish

## 617 - 2" Post Floor Flange Casting



2" square tube fits over stub, 1 1/2" tube fits inside. Makes a strong base plate.

Catalog No	Item	Length	Pcs / Ctn	Color
61700	2" Post Floor Flange Casting	3.375" x 1.375"	25	Mill Finish

## 219 - 3" Post Extruded Mounting Flange

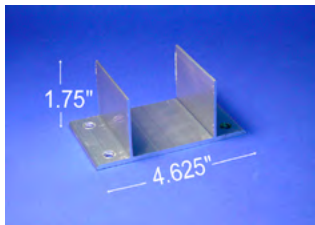

Extruded aluminum flange. Used as a top or bottom mounting flange. Flanges fit inside 3" post leaving holes for anchoring fasteners exposed.

Catalog No	Item	Length	Pcs / Ctn
21900	3" Post Extruded Mounting Flange	4.625" x 2.75" x 1.875"	25
Available in Mill Finish & White			

## 616 - 3" Post Concealed Flange Casting

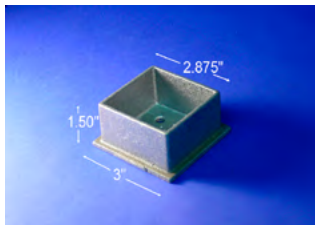

Cast aluminum flange. 3" post fits over top of stub

Catalog No	Item	Length	Pcs / Ctn
61600	3" Post Concealed Flange Casting	3" x 3" x 1.5"	25
Available in Mill Finish only			

## 616A - 3" Post Concealed Flange Casting w/ Tabs

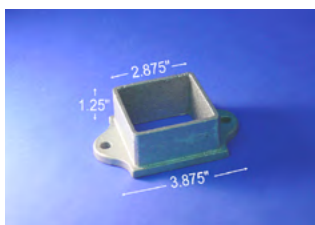

Cast aluminum flange. 3" post fits over top of stub. Ears on sides for easy fastening.

Catalog No	Item	Length	Pcs / Ctn
616A00	3" Post Concealed Flange Casting w/ Tabs	4" x 3" x 1.5"	25
Available in Mill Finish only			

### 224 - 3" Steel Post Mounting Flange

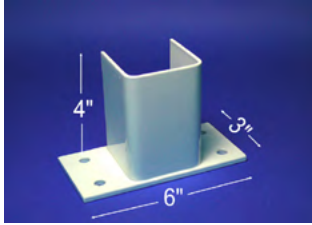

White powder coated 11 gauge welded steel flange used with our #223 3" steel post. Used top or bottom.

Catalog No	Item	Length	Pcs / Ctn
22400	3" Steel Post Mounting Flange	6" x 1.625" x 4"	10
Available in White Powder Coat			

### 621 - 1" Corner Scroll Column Base

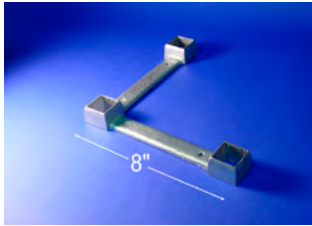

Aluminum casting for top and bottom of 1" corner column. Available in mill finish or painted for an extra charge.

Catalog No	Item	Length	Pcs / Ctn
62100	1" Corner Scroll Column Base	1" x 8" x 8"	10
Available in Mill Finish.			

### 622 - 1" Flat Scroll Column Base

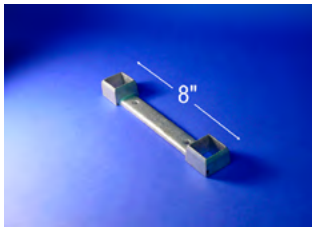

Aluminum casting used for top and bottom of 1" flat columns. Available in mill finish or painted for an extra charge.

Catalog No	Item	Length	Pcs / Ctn
62200	1" Flat Scroll Column Base	1" x 8"	10
Available in Mill Finish.			

### 623 - 1½" Corner Scroll Column Base

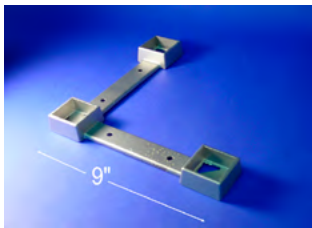

Aluminum casting used for top and bottom of 1 1/2" corner columns. Available in mill finish or painted for an extra charge.

Catalog No	Item	Length	Pcs / Ctn
62300	1½" Corner Scroll Column Base	1" x 9" x 9"	10
Available in Mill Finish.			

### 624 - 1½" Flat Scroll Column Base

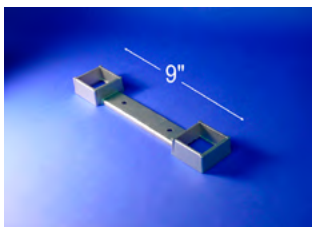

Aluminum casting used for top and bottom of 1 1/2" flat columns. Available in mill finish or painted for an extra charge.

Catalog No	Item	Length	Pcs / Ctn
62400	1½" Flat Scroll Column Base	1" x 9"	10
Available in Mill Finish.			



# Screen Room Pre-Cut Kits & Lineals

## **SERIES 400 - SCREEN ROOM PRE-CUT KITS & LINEALS**

Pre-cut screen room kits, enclosure lineals, kick panel, clips, and more.



**Crest**  
Aluminum

Photo courtesy of Niagara Awning Co - New York



**437 - 2"x2" Extruded Screen Enc Frame**

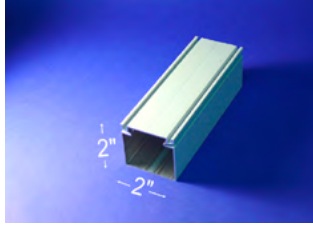

Used as the major upright for construction of screen or glass enclosures. Features an extra deep kickpanel groove and serrated spline channel to ensure screen fabric stays tight. Made of 6063-T6 Aluminum alloy for extra strength.

Catalog No	Item	Length	Pcs / Ctn	Gauge
43724	2"x2" Extruded Screen Enc Frame	24'	8	.050
Available in White, Brown, Bronze, Clay & now <b>Black!</b>				

**437D - Door Frame Adapter Channel**

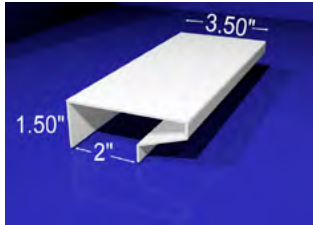

Fits on 2"x2" enclosure frame and provides a 3 1/2" jamb for mounting doors and door closures or windows. Not a required item, but well worth it for better appearance and ease of installation.

Catalog No	Item	Length	Pcs / Ctn	Gauge
437D07	Door Frame Adapter Channel	7'	1	.050

**438 - 2"x2" Extruded Screen Enc Corner**

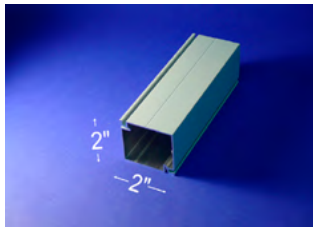

Provides a strong and clean corner for enclosures and eliminates the need to join sections together, recommended for on site construction. Made of 6063-T6 aluminum alloy for added strength.

Catalog No	Item	Length	Pcs / Ctn	Gauge
43816	2"x2" Extruded Screen Enc Corner	16'	8	.050
Available in White, Brown, Bronze, Clay & now <b>Black!</b>				

**438I - 2"x2" Extruded Screen Enc Inside Corner**

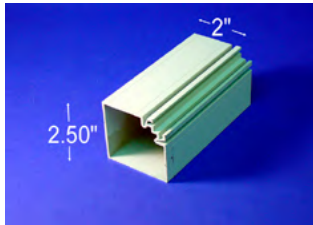

This section gives you an "inside" corner without having to jury rig several pieces together, a very heavy part with .080 wall thickness. Made of 6063-T6 aluminum alloy for extra strength, enables you to build a room and then screen it from inside, very handy on second floor porches.

Catalog No	Item	Length	Pcs / Ctn	Gauge
438I16	2"x2" Extruded Screen Enc Inside Corner	16'	8	.050
Available in Brown only				

**439 - 1"x2" Extruded Screen Enc Mullion**

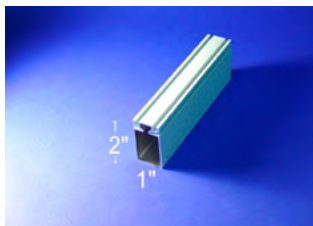

Used as a horizontal section to cap kickpanel and begin screen section, has double screen and spline grooves, also used as an upright frame on some light applications. Made of 6063-T6 aluminum alloy for added strength.

Catalog No	Item	Length	Pcs / Ctn	Gauge
43920	1"x2" Extruded Screen Enc Mullion	20'	9	.050
Available in White, Brown, Bronze, Clay & now <b>Black!</b>				

**440 - 1"x2" Extruded Screen Enc Frame**

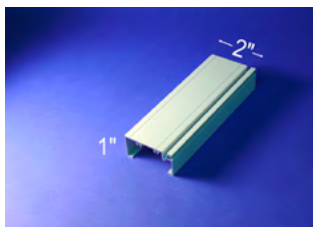

Used inside the #441 1"x2" expander at the top and bottom of the wall. Opening prevents rocking on expander fasteners. (2) screw bosses allow this part to be square cut and assembled into panels with leader screws and mulled together with #446 "H" channel. 6063-T6 alloy

Catalog No	Item	Length	Pcs / Ctn	Gauge
44024	1"x2" Extruded Screen Enc Frame	24'	12	.050
Available in White, Brown, Bronze, Clay & now <b>Black!</b>				

### 441 - 1"x2" Extruded Screen Enc Expander

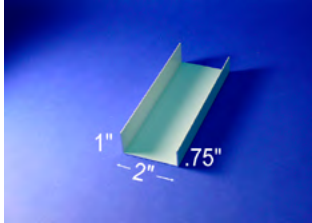

Our expander is designed with a 3/4" front leg and a 1" back leg, this exposes the screen spline groove on the #440 1"x2" frame and also helps prevent water from backing up into room, ribs on bottom promote good sealant adhesion. 6063-T6 alloy

Catalog No	Item	Length	Pcs / Ctn	Gauge
44120	1"x2" Extruded Screen Enc Expander	20'	12	.050
Available in White, Brown, Bronze, Clay & now <b>Black!</b>				

### 75-60601 - 2"x2" Extruded H Channel

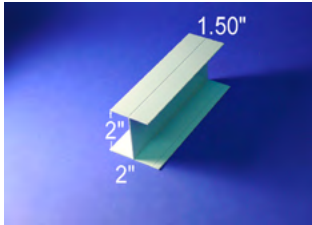

Accepts #440 1"x2" or #437 2"x2" frames when building screen panels, front face is 1.57" and allows access to screen spline groove after installation to make repairs easier, rear face is 2". 6063-T6 aluminum alloy.

Catalog No	Item	Length	Pcs / Ctn	Gauge
75-60601	2"x2" Extruded H Channel	24'	1	.062
Available in White, Almond, Brown, Bronze, & Clay				

### 411 - 1"x1" Roll Formed Screen Frame

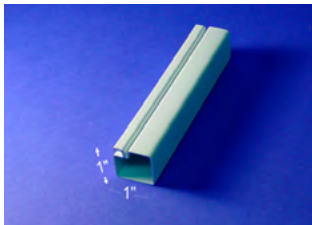

1"x1" square roll formed lockseam screen frame.

Catalog No	Item	Length	Pcs / Ctn	Gauge
41116	1"x1" Roll Formed Screen Frame	16'	30	.032
Available in White, Bronze & Clay				

### 43400 - .024 18" Stucco Embossed Kick Panel Coil

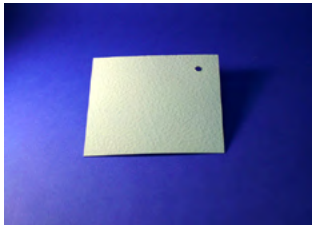

18" tall .024" stucco embossed coil used as kick panel in our 2" screen rooms.

Catalog No	Item	Length	Pcs / Ctn	Gauge
43400	.024 18" Stucco Embossed Kick Panel Coil	100'	1 Roll	.024
Available in White, Brown, Bronze, & Clay				

### 43500 - .024 12" or 24" Stucco Embossed Kick Panel Coil



12" or 24" tall .024" stucco embossed coil used as kick panel in our 2" screen rooms.

Catalog No	Item	Length	Pcs / Ctn	Gauge
43512	.024 12" Stucco Embossed Kick Panel Coil	100'	1 Roll	.024
43500	.024 24" Stucco Embossed Kick Panel Coil	100'	1 Roll	.024
Available in White, Brown, Bronze, Clay & now <b>Black!</b>				

### 7700 - 2" Square Edge Panel



2" thick insulated wall panel. Used in 2" wall systems and is also used to build "end wings" for insulated patio roofs. Aluminum stucco finish.

Catalog No	Item	Length	Pcs / Ctn	Gauge
7700	4'x8' 2" Square Edge Panel	4'x8'	1	.024
7701	4'x10' 2" Square Edge Panel	4'x10'	1	.024
Available in White, Almond, Bronze, Clay, & Ivory				



**412 - 1"x1" Corner Insert**

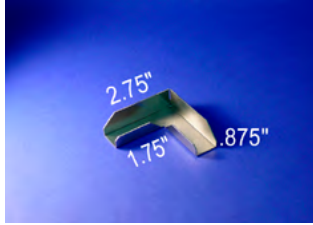

Used for producing screen panels with mitered corners. Fits inside #411 1"x1" screen frame. Mill finish .050 aluminum.

Catalog No	Item	Length	Pcs / Ctn	Gauge
41200	1"x1" Corner Insert	1"x2"x1"	100	.050

**413 - 1"x1" Mullion Clip**

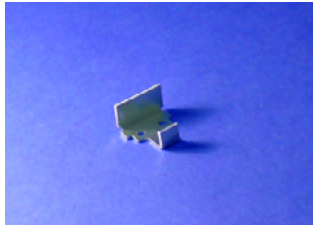

Used to fasten horizontal 1" mullion to uprights. Fits in the ends of #411 1" screen frame.

Catalog No	Item	Length	Pcs / Ctn	Gauge
41300	1"x1" Mullion Clip	-	100	.050

**420 - 1"x2" Corner Insert**

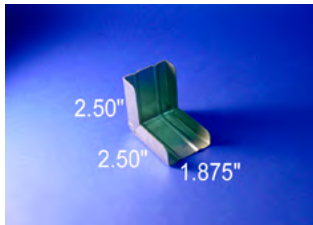

Used for producing screen panels with mitered corners. Fits inside #440 1"x2" screen frame. Mill finish .050 aluminum.

Catalog No	Item	Length	Pcs / Ctn	Gauge
42000	1"x2" Corner Insert	2"x3"x2"	100	.050

**422 - 1"x2" F Clip**

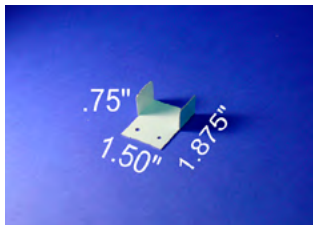

Used to join 1"x2" mullion to upright 2"x2" frames when building on job site. Fasten to mullion and position on upright then secure with screw or rivet.

Catalog No	Item	Length	Pcs / Ctn	Gauge
42200	1"x2" F Clip	-	100	.050

Available in White, Brown, Bronze, & Clay

**428 - 2"x2" End Clip Insert**

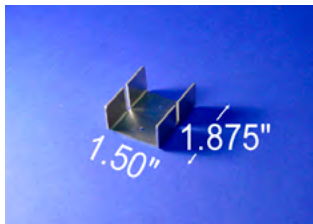

Used for joining 2"x2" enclosure frames at right angles. Fits inside 2"x2" frame so it is hidden. Available mill finish only.

Catalog No	Item	Length	Pcs / Ctn	Gauge
42800	2"x2" End Clip Insert	-	100	.050

### 432 - .145" Square Screen Spline

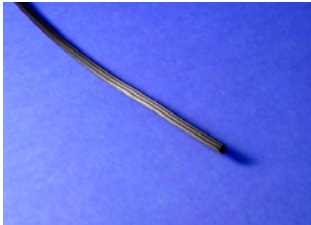

Designed for our enclosure frames. Serrated, hollow spline holds fiberglass screen in place. This spline is a little tight going in, but it will NOT come loose. 2000' per roll.

Catalog No	Item	Length	Pcs / Ctn	Gauge
43200-C-2000	.145" Square Screen Spline	2000'	1 Roll	.145"

### 432 - .165" Foam Filled Screen Spline



A foam core spline designed for our enclosure frames. Soft foam center spline holds fiberglass screen in place. The flexibility of the foam makes this spline easier to work with particularly in colder weather. 3000' per roll.

Catalog No	Item	Length	Pcs / Ctn	Gauge
43200-FOAM	.165" Foam Filled Screen Spline	3000'	1 Roll	.165"

### 436 - 3/4" x 3/4" Foam Bug Tape Roll

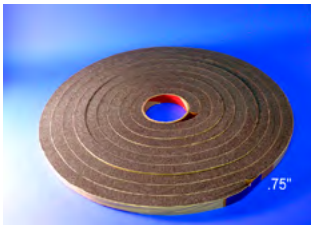

Excellent product to use for bug proofing an enclosure. Works very well at house wall behind the wall expander.

Catalog No	Item	Length	Pcs / Ctn	Gauge
43600	3/4" x 3/4" Foam Bug Tape Roll	25'	1 Roll	3/4"

### 445 - Universal Door Bracket



The best door closer bracket on the market. Made of tough nylon, won't corrode or break. Fits solidly onto 2"x2" frame & eliminates having to jury rig angle to accept door closer.

Catalog No	Item	Length	Pcs / Ctn	Gauge
44500	Universal Door Bracket	-	1	-

### 441-444 - 18x16 Fiberglass Screen -100' Roll



High quality fiberglass screen wire. Available in 36", 42", 48", 54", 60", 72", 84", and 96" rolls at 100' each. Charcoal screen only.

Catalog No	Item	Length	Pcs / Ctn	Gauge
44199	36" 18x16 Fiberglass Screen Roll	100'	1 Roll	-
442A00	42" 18x16 Fiberglass Screen Roll	100'	1 Roll	-
44200	48" 18x16 Fiberglass Screen Roll	100'	1 Roll	-
443A00	54" 18x16 Fiberglass Screen Roll	100'	1 Roll	-
44300	60" 18x16 Fiberglass Screen Roll	100'	1 Roll	-
44400	72" 18x16 Fiberglass Screen Roll	100'	1 Roll	-
444A84	84" 18x16 Fiberglass Screen Roll	100'	1 Roll	-
444A96	96" 18x16 Fiberglass Screen Roll	100'	1 Roll	-

**400**  
Signature  
**SERIES**  
screenrooms

**Why choose Crest Aluminum  
400 Series Screen Room Kits?**

**Features**

- Heavy Extruded Aluminum Frames
- Massive 2"x2" Main Frames
- Available in 2 wall heights - 8' or 10'
- All horizontal lineals cut to 3' or 4'
- All kickplates are pre-cut
- No need to inventory materials
- Available in 4 great colors
- 6063 T-6 Alloy

**Benefits**

- Stronger & Longer Lasting Room
- Stronger than 1 3/4" Systems
- Less waste / Most kits can ship UPS
- Saves time / Easy transport to job site
- No bulky rolls & less damage
- Save warehouse space & money
- More choices = More sales
- 50% stronger than the competitions 6063 T-5

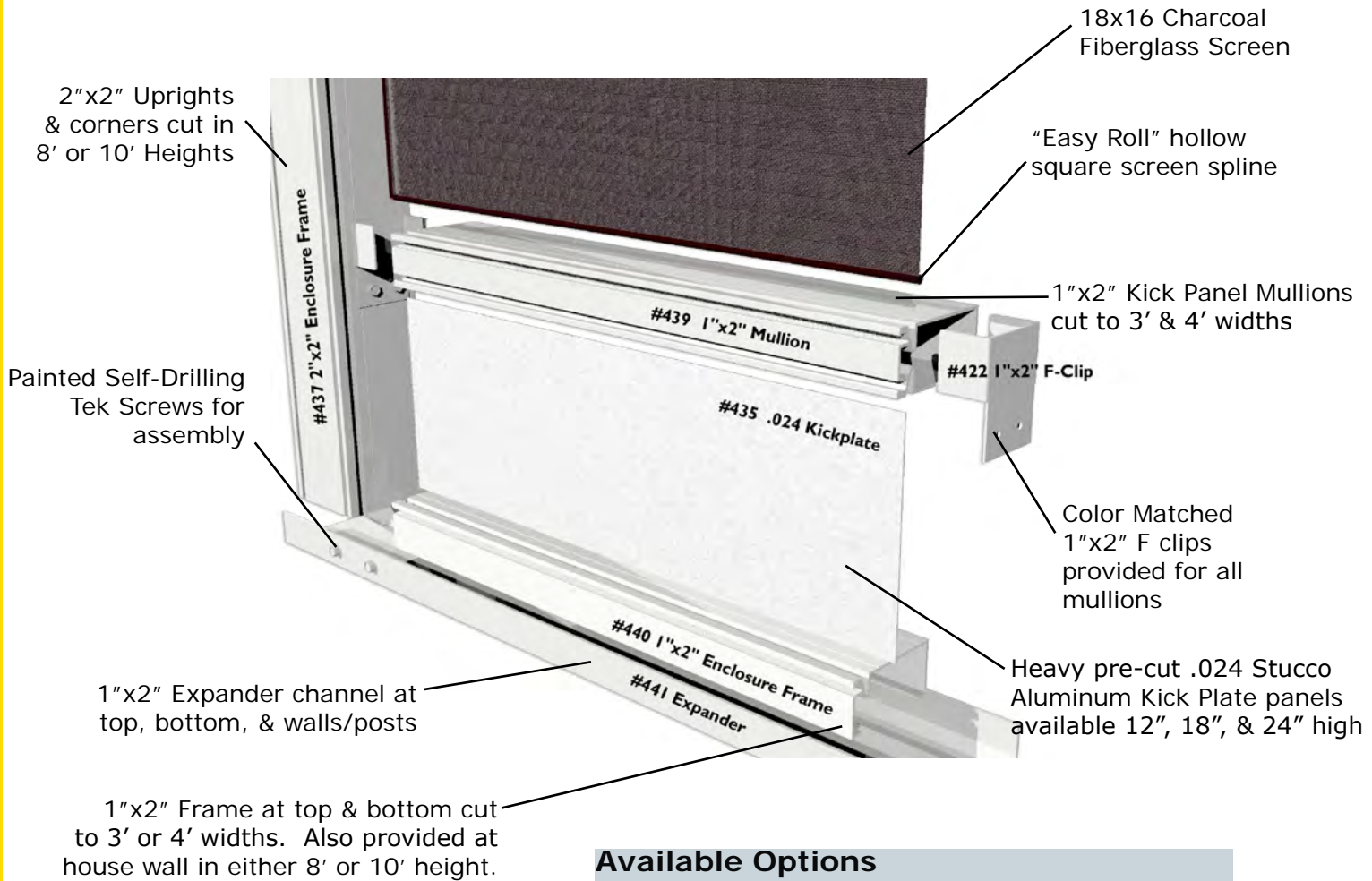

**Available Options**

- Heavy Duty 1 1/4" Comfort-Tite Screen Doors
- Extra sets of 1"x2" mullions when installing windows into the walls.
- Extra 1"x2" expander & screen frame when installing in between existing posts.
- Extruded Inside Corner for special layouts and for screening from the inside.



## 2"x2" Heavy Duty Extruded Aluminum Pre-Cut Screen Room Kit Pricing

### Pre-Cut Screen Room Kits Priced per Perimeter Foot

Perimeter foot = The total of all 3 wall dimensions (length of side walls + length of front)

#### Optional Items (\*\* Required when installing in between existing posts)

Item No.	Size	Description	List Price
850036SCR	36"x80"	36" x 80" Comfort-Tite Hi Lite Screen Door	
43708	8'	Extra 8' 2"x2" Screen Frame	
43710	10'	Extra 10' 2"x2" Screen Frame	
43903	3'	Extra 3' 1"x2" Mullion	
43904	4'	Extra 4' 1"x2" Mullion	
**44008	8'	Extra 8' 1"x2" Screen Frame	
**44010	10'	Extra 10' 1"x2" Screen Frame	
**44108	8'	Extra 8' 1"x2" Expander	
**44110	10'	Extra 10' 1"x2" Expander	
438I08	8'	Extra 8' 2"x2" Inside Corner	
438I10	10'	Extra 10' 2"x2" Inside Corner	
43808	8'	Extra 8' 2"x2" Outside Corner	
43810	10'	Extra 10' 2"x2" Outside Corner	

#### Ordering Notes

Pre-Cut Screen Room Kits include all items listed as standard on page 56.

Pricing is based upon the perimeter measurements of the room, using standard mullion widths of 3' or 4'. Perimeter footage is rounded up as required.

**Example:** A 5' projection x 10' wide room would be priced as a 6' projection x 10' wide.

Please note that when installing screen walls in between existing posts, (2) extra 1"x2" Frames and (2) extra 1"x2" expanders will be required for each existing post. Please send diagram with post locations.



# **Insulated Roof & Room Components**

**SERIES 7500 - Insulated Roof & Room  
Panels, Lineals, and Accessories**



Insulated Roof & Room

**Crest**  
Aluminum

Photo courtesy of AAA Remodeling Co - Missouri





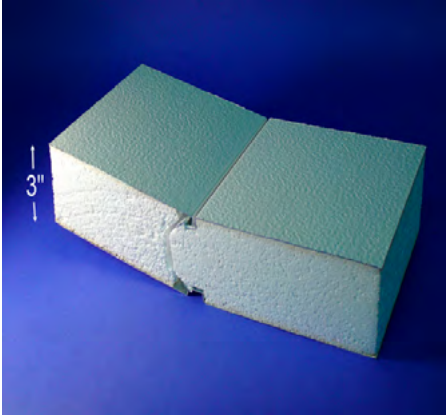

## 75xx - 3" Interlocking Roof Panels



Elite Interlock panels feature a positive lock system with interlocking foam for consistent thermal separation, a large internal drain system, and expanded polystyrene core.

Catalog No	Width	Length	Thickness	Foam Density / Aluminum Skin
7507-2	2'	7'	3"	1lb foam / .024 aluminum
7507	4'	7'	3"	1lb foam / .024 aluminum
7508-2	2'	8'	3"	1lb foam / .024 aluminum
7508	4'	8'	3"	1lb foam / .024 aluminum
7509-2	2'	9'	3"	1lb foam / .024 aluminum
7509	4'	9'	3"	1lb foam / .024 aluminum
7510-2	2'	10'	3"	1lb foam / .024 aluminum
7510	4'	10'	3"	1lb foam / .024 aluminum
7511-2	2'	11'	3"	1lb foam / .024 aluminum
7511	4'	11'	3"	1lb foam / .024 aluminum
7512-2	2'	12'	3"	1lb foam / .024 aluminum
7512	4'	12'	3"	1lb foam / .024 aluminum
7513-2	2'	13'	3"	1lb foam / .024 aluminum
7513	4'	13'	3"	1lb foam / .024 aluminum
7514-2	2'	14'	3"	1lb foam / .024 aluminum
7514	4'	14'	3"	1lb foam / .024 aluminum
7515-2	2'	15'	3"	1lb foam / .024 aluminum
7515	4'	15'	3"	1lb foam / .024 aluminum
7516-2	2'	16'	3"	1lb foam / .024 aluminum
7516	4'	16'	3"	1lb foam / .024 aluminum
75xx-2	2'	Custom	3"	1lb foam / .024 aluminum
75xx	4'	Custom	3"	1lb foam / .024 aluminum
75xxA	Add per Square Foot		3"	Upcharge for 2lb density foam
75xx-032	Add per Square Foot		3"	Upcharge for .032 aluminum facing
75xx-B	Add per foot of length		3"	2"x3" Fan/Electrical Beam

Standard Stock Sizes

-  White (Stucco or Cedar)
-  Ivory (Stucco only)
-  Almond (Stucco or Cedar)
-  Clay (Stucco only)
-  Bronze\* (Stucco only)

\*Bronze panels are not warranted against delamination

All panels are also available "ribbed". Ribbed panels have a groove that runs the length of the panel every 8".



Elite panels have undergone a series of rigorous tests to prove that they meet or exceed energy efficiency guidelines established by the U.S. Environmental Protection Agency and the U.S. Department of Energy.

## 7524 - 3" Insulated Roof Wall Channel

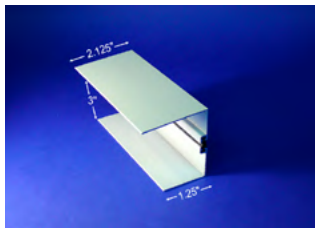

Channel used for attaching insulated roof panels to existing wall or fascia. Thermally broken for a consistent separation between inside and outside surfaces. Pre-pitched for 3/12 roof slope but can easily accommodate others.

Catalog No	Item	Length	Colors
7524	3" Insulated Roof Wall Channel	24'	White, Almond, Bronze, Clay, Ivory
7524-12	3" Insulated Roof Wall Channel	12'	White, Almond, Bronze, Clay, Ivory
7524-NT	3" Roof Non-Thermal Wall Channel	24'	White

## 7524W - 3" Insulated Roof Hinged Wall Mount

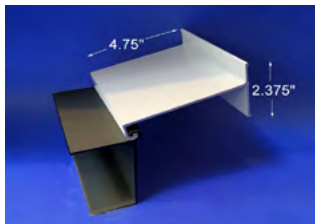

This wall mount is used with #7524H to create a hinged hanging rail system for the 3" Insulated roofs. This piece is mounted to the home, trailer, or building and engages with the hanging rail.

Catalog No	Item	Length	Colors
7524W-20	3" Insulated Roof Hinged Wall Mount	20'	White
7524W-10	3" Insulated Roof Hinged Wall Mount	10'	White

## 7524H - 3" Insulated Roof Hinged Receiving Rail

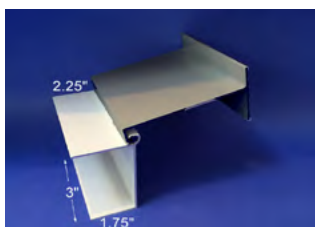

Used in place of the #7524 Fixed hanging rail, this hinged hanging rail allows for greater flexibility when installing the roof. This hinged mounting system also allows for smaller covers to be lowered, in essence "closing up" a camper for added security during extended periods of time away.

Catalog No	Item	Length	Colors
7524H-20	3" Insulated Roof Hinged Receiving Rail	20'	White
7524H-10	3" Insulated Roof Hinged Receiving Rail	10'	White

## 7562 - 3" Insulated Roof Gutter

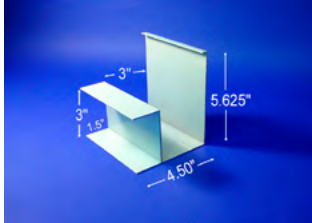

Provides a built-in 3"x5" gutter for the insulated roof system. Fits flush with the bottom of the roof panels.

Catalog No	Item	Length	Colors
7562	3" Insulated Roof Gutter	24'	White, Almond, Bronze, Clay, Ivory
7562-12	3" Insulated Roof Gutter	12'	White, Almond, Bronze, Clay, Ivory
7500	3" Gutter Splice	1"	Mill Finish

## 7572 - 3" Insulated Roof Side Fascia

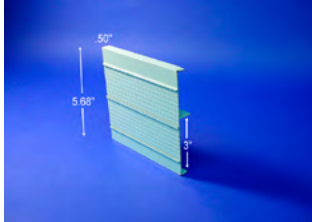

Finishes sides of roof and caps ends of gutter. Project 2½" above the roof to direct water into the front gutter.

Catalog No	Item	Length	Colors
7572	3" Insulated Roof Side Fascia	25'	White, Almond, Bronze, Clay, Ivory
7572-12	3" Insulated Roof Side Fascia	12'-6"	White, Almond, Bronze, Clay, Ivory

## 7552 - 3" Insulated Roof Drip Edge Fascia

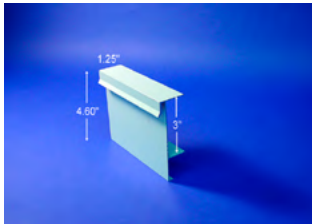

Extruded trim and closure used on the sides and front of roof. Duplicates fascia and roof edge profile. Allows for the application of "K" style residential gutter. Fascia is flush with TOP of roof. A simple miter at the corners makes for a clean looking installation.

Catalog No	Item	Length	Colors
7552	3" Insulated Roof Drip Edge Fascia	25'	White, Almond, Bronze, Clay, Ivory
7552-12	3" Insulated Roof Drip Edge Fascia	12'-6"	White, Almond, Bronze, Clay, Ivory

## 7565 - 3" Insulated Roof 3/12 Fixed Ridge Beam



Used to join roof panels together for gable roof installation as well as bay walls. Thermally broken, pitch is 3" over 12" but will accommodate other pitches.

Catalog No	Item	Length	Colors
7565	3" Insulated Roof 3/12 Fixed Ridge Beam	24'	White & Almond
7565-12	3" Insulated Roof 3/12 Fixed Ridge Beam	12'	White & Almond

## 7565-ADJ - 3" Insulated Roof Adjustable Ridge Beam

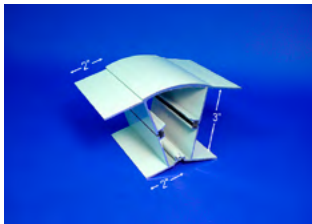

Used to join roof panels together for gable roof installation as well as bay walls. Thermally broken, pitch is variable and is designed to accommodate several different gable style roofs. This beam is often used in conjunction with the Elite 2000 2.625" carry beams.

Catalog No	Item	Length	Colors
7565-ADJ	3" Insulated Roof Adjustable Ridge Beam	24'	White & Almond
7565-ADJ-12	3" Insulated Roof Adjustable Ridge Beam	12'	White & Almond

## 324A - #14 x 4" Self-Drilling Tek w/ Bonded Washer

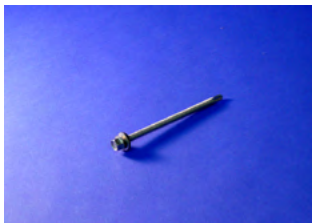

Used to fasten the roof system to the structural members below. Used with our #32500 1" fender washer.

Catalog No	Item	Length
324A00	#14 x 4" Self-Drilling Tek w/ Bonded Washer	4"
32500	¼" x 1 ½" Fender Washer	-



## 75xx-4 - 4" Interlocking Roof Panels

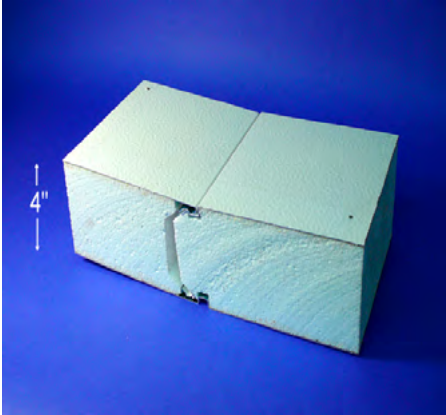

Elite Interlock panels feature a positive lock system with interlocking foam for consistent thermal separation, a large internal drain system, and expanded polystyrene core.

Catalog No	Width	Length	Thickness	Foam Density / Aluminum Skin
7507-4-2	2'	7'	4"	1lb foam / .024 aluminum
7507-4	4'	7'	4"	1lb foam / .024 aluminum
7508-4-2	2'	8'	4"	1lb foam / .024 aluminum
7508-4	4'	8'	4"	1lb foam / .024 aluminum
7509-4-2	2'	9'	4"	1lb foam / .024 aluminum
7509-4	4'	9'	4"	1lb foam / .024 aluminum
7510-4-2	2'	10'	4"	1lb foam / .024 aluminum
7510-4	4'	10'	4"	1lb foam / .024 aluminum
7511-4-2	2'	11'	4"	1lb foam / .024 aluminum
7511-4	4'	11'	4"	1lb foam / .024 aluminum
7512-4-2	2'	12'	4"	1lb foam / .024 aluminum
7512-4	4'	12'	4"	1lb foam / .024 aluminum
7513-4-2	2'	13'	4"	1lb foam / .024 aluminum
7513-4	4'	13'	4"	1lb foam / .024 aluminum
7514-4-2	2'	14'	4"	1lb foam / .024 aluminum
7514-4	4'	14'	4"	1lb foam / .024 aluminum
7515-4-2	2'	15'	4"	1lb foam / .024 aluminum
7515-4	4'	15'	4"	1lb foam / .024 aluminum
7516-4-2	2'	16'	4"	1lb foam / .024 aluminum
7516-4	4'	16'	4"	1lb foam / .024 aluminum
75xx-4-2	2'	Custom	4"	1lb foam / .024 aluminum
75xx-4	4'	Custom	4"	1lb foam / .024 aluminum
75xxA-4	Add per Square Foot		4"	Upcharge for 2lb density foam
75xx-4-032	Add per Square Foot		4"	Upcharge for .032 aluminum facing
75xx-4-B	Add per foot of length		4"	2"x3" Fan/Electrical Beam

- White (Stucco or Cedar)
- Ivory (Stucco only)
- Almond (Stucco or Cedar)
- Clay (Stucco only)
- Bronze\* (Stucco only)

\*Bronze panels are not warranted against delamination

All panels are also available "ribbed". Ribbed panels have a groove that runs the length of the panel every 8".



Elite panels have undergone a series of rigorous tests to prove that they meet or exceed energy efficiency guidelines established by the U.S. Environmental Protection Agency and the U.S. Department of Energy.

## 7524-4 - 4" Insulated Roof Wall Channel

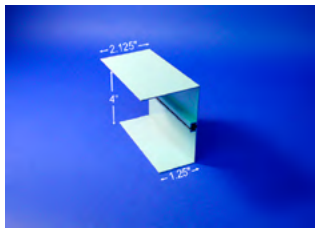

Channel used for attaching insulated roof panels to existing wall or fascia. Thermally broken for a consistent separation between inside and outside surfaces. Pre-pitched for 3/12 roof slope but can easily accommodate others.

Catalog No	Item	Length	Colors
7524-4	4" Insulated Roof Wall Channel	24'	White, Almond, Bronze, Clay
7524-4-12	4" Insulated Roof Wall Channel	12'	White, Almond, Bronze, Clay

## 7562A - 3 3/4" Insulated Roof Gutter

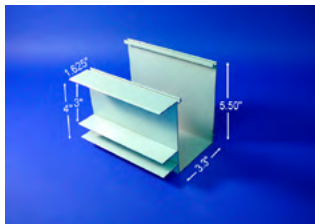

Provides a built-in 3"x5" gutter for either the 3" or 4" insulated roof system. Protects core material from possible damage. Spline groove along top edges allows for screening to eliminate debris.

Catalog No	Item	Length	Colors
7562A	3 3/4" Insulated Roof Gutter	24'	White, Almond, Bronze
7562A-12	3 3/4" Insulated Roof Gutter	12'	White, Almond, Bronze

## 7572A - 3 3/4" Insulated Roof Side Fascia

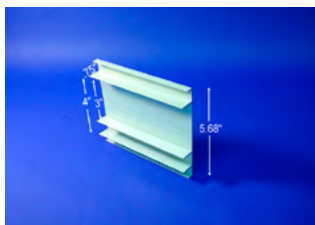

Finishes the sides of the roof and caps the ends of the gutter. Projects above the roof to direct water into the front gutter. Used only with the #7562A 3 3/4" gutter.

Catalog No	Item	Length	Colors
7572A	3 3/4" Insulated Roof Side Fascia	25'	White, Almond, Bronze
7572A-12	3 3/4" Insulated Roof Side Fascia	12'-6"	White, Almond, Bronze

### 7552-4 - 4" Insulated Roof Drip Edge Fascia



Extruded trim and closure used on the sides and front of roof. Duplicates fascia and roof edge profile. Allows for the application of "K" style residential gutter. Fascia is flush with TOP of roof. A simple miter at the corners makes for a clean looking installation.

Catalog No	Item	Length	Colors
7552-4	4" Insulated Roof Drip Edge Fascia	25'	White, Almond, Bronze, Clay, Ivory
7552-4-12	4" Insulated Roof Drip Edge Fascia	12'-6"	White, Almond, Bronze, Clay, Ivory

### 7565-ADJ-4 - 4" Insulated Roof Adjustable Ridge Beam

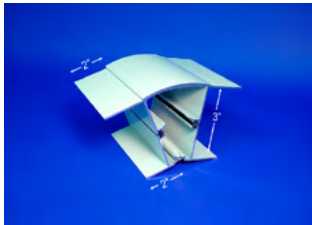

Used to support load and connect panels on a gabled roof. Designed to achieve slopes of 1/12 to 7/12. Thermally broken for a consistent separation between outside and inside surfaces.

Catalog No	Item	Length	Colors
7565-ADJ-4	4" Adjustable Ridge Beam	24'	White
7565-ADJ-4-12	4" Adjustable Ridge Beam	12'	White

### 7904-4 - 4" Non-Thermal Receiving Channel

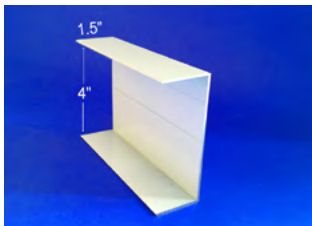

4" non thermal receiving channel can be used as a starter channel at the host structure where panels meet the structure at a 90 degree angle. 4" panel fits inside, available in White only.

Catalog No	Item	Length	Colors
7904-4	4" Non-Thermal Receiving Channel	24'	White

### 324 - #14 x 5" Self-Drilling Tek w/ Bonded Washer



Used to fasten the roof system to the structural members below. Used with our #32500 1" fender washer.

Catalog No	Item	Length
32400-6	#14 x 5" Self-Drilling Tek w/ Bonded Washer	5"
32500	1/4" x 1 1/2" Fender Washer	-

## 75xx-6 - 6" Interlocking Roof Panels

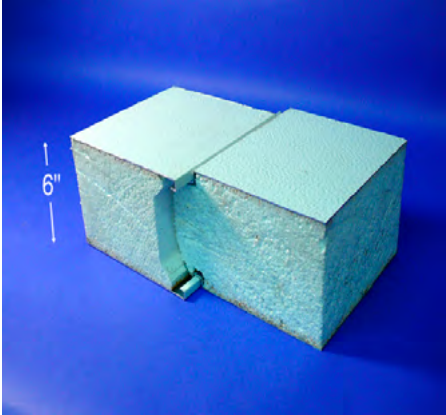

Elite Interlock panels feature a positive lock system with interlocking foam for consistent thermal separation, a large internal drain system, and expanded polystyrene core.

Catalog No	Width	Length	Thickness	Foam Density / Aluminum Skin
7507-6-2	2'	7'	6"	1lb foam / .024 aluminum
7507-6	4'	7'	6"	1lb foam / .024 aluminum
7508-6-2	2'	8'	6"	1lb foam / .024 aluminum
7508-6	4'	8'	6"	1lb foam / .024 aluminum
7509-6-2	2'	9'	6"	1lb foam / .024 aluminum
7509-6	4'	9'	6"	1lb foam / .024 aluminum
7510-6-2	2'	10'	6"	1lb foam / .024 aluminum
7510-6	4'	10'	6"	1lb foam / .024 aluminum
7511-6-2	2'	11'	6"	1lb foam / .024 aluminum
7511-6	4'	11'	6"	1lb foam / .024 aluminum
7512-6-2	2'	12'	6"	1lb foam / .024 aluminum
7512-6	4'	12'	6"	1lb foam / .024 aluminum
7513-6-2	2'	13'	6"	1lb foam / .024 aluminum
7513-6	4'	13'	6"	1lb foam / .024 aluminum
7514-6-2	2'	14'	6"	1lb foam / .024 aluminum
7514-6	4'	14'	6"	1lb foam / .024 aluminum
7515-6-2	2'	15'	6"	1lb foam / .024 aluminum
7515-6	4'	15'	6"	1lb foam / .024 aluminum
7516-6-2	2'	16'	6"	1lb foam / .024 aluminum
7516-6	4'	16'	6"	1lb foam / .024 aluminum
75xx-6-2	2'	Custom	6"	1lb foam / .024 aluminum
75xx-6	4'	Custom	6"	1lb foam / .024 aluminum
75xxA-6	Add per Square Foot		6"	Upcharge for 2lb density foam
75xx-6-032	Add per Square Foot		6"	Upcharge for .032 aluminum facing
75xx-6-B	Add per foot of length		6"	2"x3" Fan/Electrical Beam

- White (Stucco or Cedar)
- Ivory (Stucco only)
- Almond (Stucco or Cedar)
- Clay (Stucco only)
- Bronze\* (Stucco only)

\*Bronze panels are not warranted against delamination

All panels are also available "ribbed". Ribbed panels have a groove that runs the length of the panel every 8".



Elite panels have undergone a series of rigorous tests to prove that they meet or exceed energy efficiency guidelines established by the U.S. Environmental Protection Agency and the U.S. Department of Energy.

## 7524-6 - 6" Insulated Roof Wall Channel

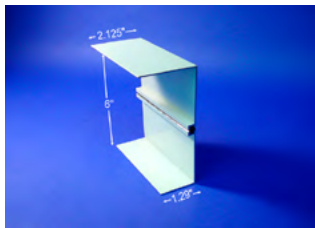

Channel used for attaching insulated roof panels to existing wall or fascia. Thermally broken for a consistent separation between inside and outside surfaces. Pre-pitched for 3/12 roof slope but can easily accommodate others.

Catalog No	Item	Length	Colors
7524-6	6" Insulated Roof Wall Channel	24'	White, Almond, Bronze, Clay
7524-6-12	6" Insulated Roof Wall Channel	12'	White, Almond, Bronze, Clay

## 7562-6 - 6" Insulated Roof Gutter



Provides a built-in 3"x6" gutter for either the 6" insulated roof system. Protects core material from possible damage. Available in White only.

Catalog No	Item	Length	Colors
7562-6	6" Insulated Roof Gutter	24'	White
7562-6-12	6" Insulated Roof Gutter	12'	White

## 7572-6 - 6" Insulated Roof Side Fascia

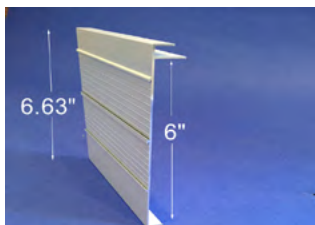

Finishes the sides of the roof and caps the ends of the gutter. Projects above the roof to direct water into the front gutter. Used only with the #7562-6 6" gutter. Available in White only.

Catalog No	Item	Length	Colors
7572-6	6" Insulated Roof Side Fascia	25'	White
7572-6-12	6" Insulated Roof Side Fascia	12'-6"	White

### 7552-6 - 6" Insulated Roof Drip Edge Fascia



Extruded trim and closure used on the sides and front of roof. Duplicates fascia and roof edge profile. Allows for the application of "K" style residential gutter. Fascia is flush with TOP of roof. A simple miter at the corners makes for a clean looking installation.

Catalog No	Item	Length	Colors
7552-6	6" Insulated Roof Drip Edge Fascia	25'	White, Almond, Bronze, Clay
7552-6-12	6" Insulated Roof Drip Edge Fascia	12'-6"	White, Almond, Bronze, Clay

### 7565-ADJ-6 - 6" Insulated Roof Adjustable Ridge Beam

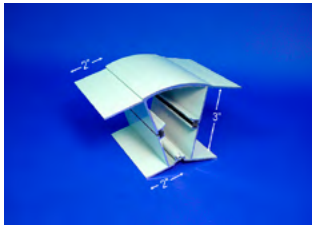

Used to support load and connect panels on a gabled roof. Designed to achieve slopes of 1/12 to 7/12. Thermally broken for a consistent separation between outside and inside surfaces.

Catalog No	Item	Length	Colors
7565-ADJ-6	6" Adjustable Ridge Beam	24'	White

### 7904-6 - 6" Non-Thermal Receiving Channel

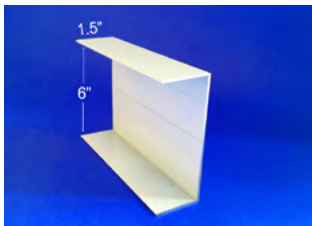

6" non thermal receiving channel can be used as a starter channel at the host structure where panels meet the structure at a 90 degree angle. 6" panel fits inside, available in White only.

Catalog No	Item	Length	Colors
7904-6	6" Non-Thermal Receiving Channel	24'	White

### 324 - #14 x 8" Self-Drilling Tek w/ Bonded Washer



Used to fasten the roof system to the structural members below. Used with our #32500 1" fender washer.

Catalog No	Item	Length
32400-8	#14 x 8" Self-Drilling Tek w/ Bonded Washer	8"
32500	1/4" x 1 1/2" Fender Washer	-



## 75SKYLITE - Polycarbonate Double Dome Skylight

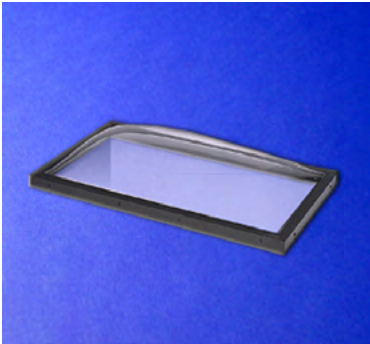

If you are looking for a low profile, reasonably priced yet durable solution for your skylight installation project, this Sun-Tek Self-Flashing model might be the one to choose. Bronze tint polycarbonate double-dome skylight comes complete with pre-cut thermally broken framing extrusions and installation tapes. Minimum pitch of 3:12 required.

Catalog No	Width	Length	Item	Frame Color
75SKYLITE	2'	4'	Insulated Roof Polycarbonate Dome Skylight	White

## 75SKYLITE-POLY - Fixed Glass Skylight

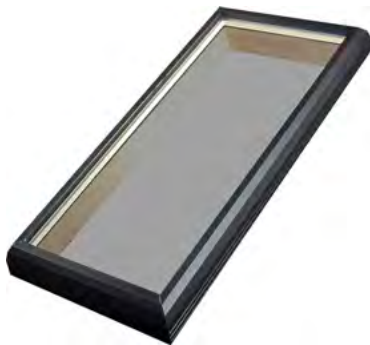

A curb mount glass skylight. This unit features fixed insulated glass filled with Argon gas and coated with a reflective Low-E film. Skylight kit comes with snap-in interior vinyl trim pieces to finish off the inside of the opening. Trim pieces are sized according to the roof thickness. Minimum pitch of 3:12 required.

Catalog No	Width	Length	Item	Frame Color
75SKYLITE-POLY	2'	4'	Insulated Roof Fixed Glass Skylight	White

## 75SKYLIT-POLY-VN - Venting Glass Skylight



A curb mount glass skylight. This unit features a venting insulated glass panel filled with Argon gas and coated with a reflective Low-E film. Skylight kit comes with snap-in interior vinyl trim pieces to finish off the inside of the opening. Trim pieces are sized according to the roof thickness. Minimum pitch of 3:12 required.

Catalog No	Width	Length	Item	Frame Color
75SKYLIT-POLY-VN	2'	4'	Insulated Roof Vented Glass Skylight	White



## 75SPRAY - Elite Touch Up Spray Paint



12oz Spray paint custom matched to the Elite panels and extrusions.

Catalog No	Item	Size	Colors
75SPRAY	Elite Extrusion Spray Paint	12 oz	White, Almond, Bronze, Ivory, Clay
75SPRAY-PAN	Elite Panel Spray Paint	12 oz	White, Almond, Bronze, Ivory, Clay

## 375 - 4" Peel & Seal® PowerBond™ 250 Tape - 50' Roll



Peel & Seal® PowerBond™ White 250 is thinner and more aggressive than normal Peel & Seal®, making it easier to install. It is specifically designed to tape seams on insulated aluminum panels or can be used as a flashing material for roof and gutter repair, window flashing and as a general-purpose waterproofing product.

Catalog No	Item	Length	Colors
37500	4" Peel n Seal PowerBond 250' Roll	50'	White

## 7712 - 2" F Base Channel

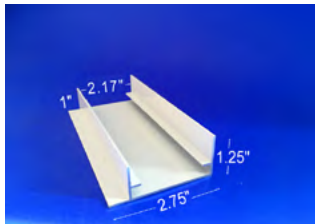

2" base channel designed to anchor wall panels and extruded vertical members to foundation.

Catalog No	Item	Length
7712	2" F Base Channel	24'
Available White, Almond, & Bronze		

## 7713 - 2" Sloped Base Channel

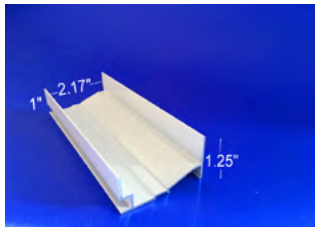

2" base channel designed to anchor wall panels and extruded vertical members to foundation. Sloped channel diverts any moisture intrusion to weep out before it can enter occupied space.

Catalog No	Item	Length
7713	2" Sloped Base Channel	24'
Available White, Almond, Bronze, & Clay		

## 7714 - 2" Cabana Base Channel

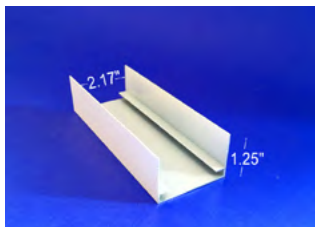

2" base channel designed to anchor wall panels and extruded vertical members to foundation. Can also be used as a top cap.

Catalog No	Item	Length
7714	2" Cabana Base Channel	24'
Available White, Almond, & Bronze		

## 7719 - 2" Corner Channel - 90°

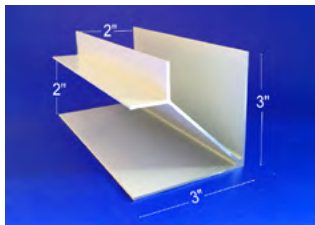

2" corner channel designed for vertical support and used to connect fill panels or wall sections at 90° corners.

Catalog No	Item	Length
7719	2" Corner Channel - 90°	24'
Available White, Almond, Bronze, & Clay		

## 7719A - 2" Corner Channel - 22.5°

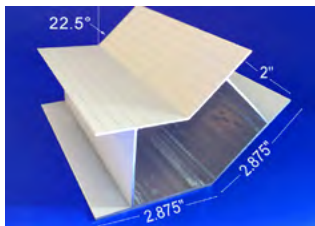

2" corner channel designed for vertical support and used to connect fill panels or wall sections at 22.5° corners.

Catalog No	Item	Length
7719A	2" Corner Channel - 22.5°	24'
Available White only		

## 7719B - 2" Corner Channel - 45°

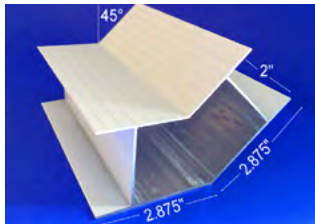

2" corner channel designed for vertical support and used to connect fill panels or wall sections at 45° corners.

Catalog No	Item	Length
7719B	2" Corner Channel - 45°	24'
Available White only		

### 7715 - 2" Flat Top Cap

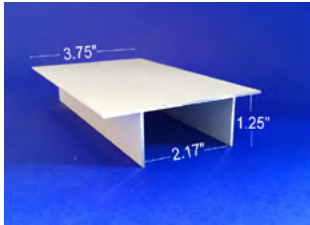

2" top cap designed to cap the wall system and connect the roof to the walls.

Catalog No	Item	Length
7715	2" Flat Top Cap	24'
Available White, Almond, & Bronze		

### 7751 - 2" 3/12 Sloped Top Cap

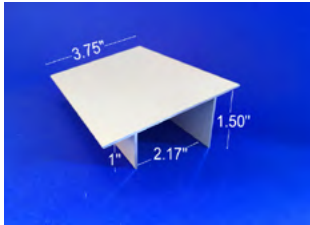

2" top cap designed to cap the wall system and connect the roof to the walls at a 3/12 slope.

Catalog No	Item	Length
7751	2" 3/12 Sloped Top Cap	24'
Available White, Almond, & Bronze		

### 7715A - 2" Adjustable Top Cap

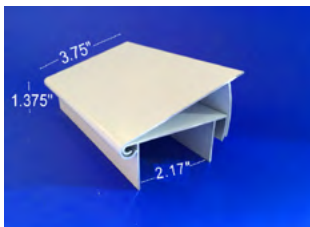

2" adjustable top cap designed to cap the eave walls of a gable room to adjust to various slopes. Adjustable from flat to 30° maximum.

Catalog No	Item	Length
7715A	2" Adjustable Top Cap	24'
Available White & Almond		

### 7718 - 2" F Wall Cap Channel

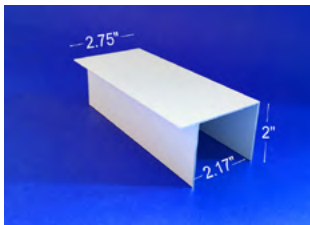

2" F-channel wall cap designed to cap wall system and connect roof to walls. Typically used when installing walls under an existing roof.

Catalog No	Item	Length
7718	2" F Wall Cap Channel	24'
Available White, Almond, Bronze, & Clay		

### 7716 - 2" Receiving Channel

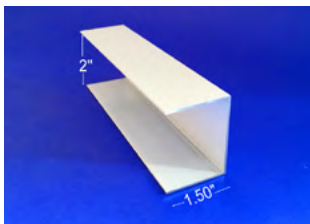

2" receiving channel used as a starter channel at the host structure. 2" panel fits inside.

Catalog No	Item	Length
7716	2" Receiving Channel	24'
Available White, Almond, Bronze, & Clay		

### 7717 - 2" 2pc Infill Channel



2" 2 piece receiving channel designed to be used a starter channel to install wall sections and infill panels within a trapped area. Used when installing walls in between existing posts and under existing roofs.

Catalog No	Item	Length
7717	2" 2pc Infill Channel	24'
Available White, Almond, Bronze, & Clay		



## 77102 - 2" Self-Mating Channel



Designed as a vertical support used to join wall sections together. May also be used as a raceway for electrical and will accommodate outlet and switch boxes. (UL Listed)

Catalog No	Item	Length
77102	2" Self-Mating Channel	24'
Available White, Almond, & Bronze		

## 77103 - 2" Male Column Channel



Designed as a vertical support used to join wall sections together. Used in conjunction with #77104 Female Column Channel.

Catalog No	Item	Length
77103	2" Male Column Channel	24'
Available White, Almond, Bronze, & Clay		

## 77104 - 2" Female Column Channel



Designed as a vertical support used to join wall sections together. Used in conjunction with #77103 Male Column Channel.

Catalog No	Item	Length
77104	2" Female Column Channel	24'
Available White, Almond, Bronze, & Clay		

## 77105 - 2" Panel Adapter Channel

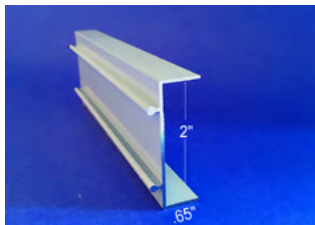

2" panel adapter slides into grooves on male and female column channels and adapts to 2" insulated panels at kneewall and transom locations.

Catalog No	Item	Length
77105	2" Panel Adapter Channel	24'
Available White, Almond, Bronze, & Clay		

## 77107 - 1 5/16"x2" Extruded Column Insert

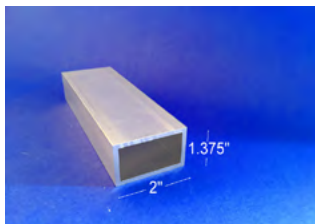

Used as a column connector between wall sections to achieve greater wall heights or as structural support for the installation of doors.

Catalog No	Item	Length
77107	1 5/16"x2" Extruded Column Insert	24'
Available Mill Finish Only		

## 77122 - 2" Column Channel w/ Screen Spline Groove

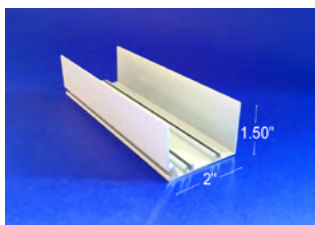

2" channel designed to be used when screen only is desired. Used as a vertical support as well as for joining wall sections together.

Catalog No	Item	Length
77122	2" Column Channel w/ Screen Spline Groove	24'
Available White only		

### 75-60601 - Elite 2" H Channel

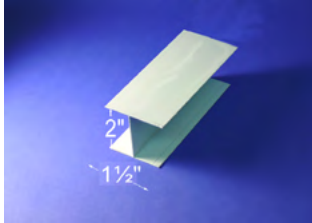

2" H channel can be used as a vertical support on both sides of windows and doors. It is also used as a connection between solid wall panels.

Catalog No	Item	Length
75-60601	Elite 2" H Channel	24'
Available White, Almond, Bronze, & Clay		

### 7716A - 2" DRC Channel

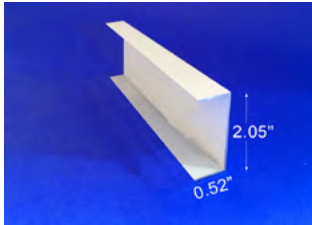

2" D.R.C. channel fits into and fills out the open area of a 2" H channel to provide a finished opening for windows or doors.

Catalog No	Item	Length
7716A	2" DRC Channel	24'
Available White, Almond, & Bronze		

### 7700 - 2" Stucco Embossed Aluminum Panel

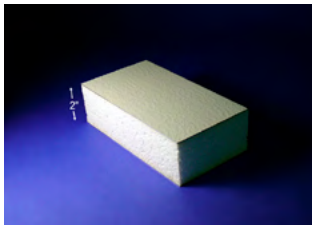

2" thick insulated wall panel. Used in 2" wall systems and is also used to build "end wings" for insulated patio roofs. Aluminum stucco finish.

Catalog No	Width	Length	Item
7700	4'	8'	2" Stucco Embossed Square Edge Panel
7701	4'	10'	2" Stucco Embossed Square Edge Panel
Available White, Almond, Bronze, Clay, & Ivory			

### 7700-CDR - 2" Cedar Embossed Aluminum Panel

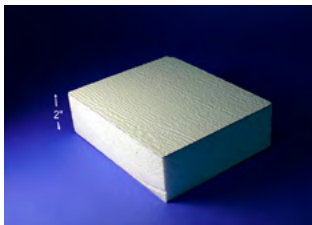

2" thick insulated wall panel. Used in 2" wall systems and is also used to build "end wings" for insulated patio roofs. Aluminum cedar wood grain embossed finish.

Catalog No	Width	Length	Item
7700-CDR	4'	8'	2" Cedar Embossed Square Edge Panel
7701-CDR	4'	10'	2" Cedar Embossed Square Edge Panel
Available White & Almond			

### 7700D - 2" Durashield Panel

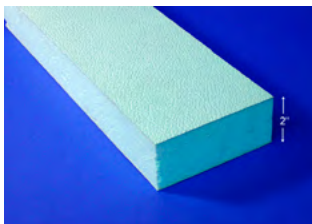

2" thick insulated wall panel. Used in 2" wall systems and is also used to build "end wings" for insulated patio roofs. Laminated with durashield on both sides.

Catalog No	Width	Length	Item
7700D	4'	8'	2" Durashield Square Edge Panel
7701D	4'	10'	2" Durashield Square Edge Panel
Available White, Almond, Bronze, & Clay			

### 7700DA - 2" Durashield/Aluminum Panel

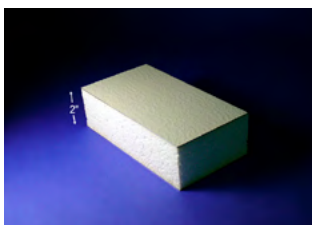

2" thick insulated wall panel. Used in 2" wall systems and is also used to build "end wings" for insulated patio roofs. Panel is laminated with stucco aluminum on one side and durashield on the other.

Catalog No	Width	Length	Item
7700-DA	4'	8'	2" Dura/Alum Square Edge Panel
7701-DA	4'	10'	2" Dura/Alum Square Edge Panel
Available White, Almond, Bronze, & Clay			

## 7901 - 3" Base Channel

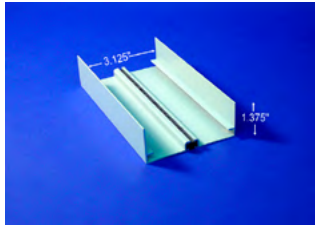

3" base channel designed to anchor wall panels and extruded vertical members to foundation.

Catalog No	Item	Length
7901	3" Base Channel	24'
Available White, Almond, & Bronze		

## 7901-A - 3" Base Channel w/ Weep

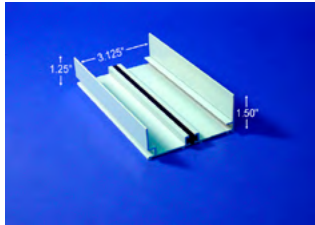

3" base channel designed to anchor wall panels and extruded vertical members to foundation. Base channel diverts any moisture intrusion to weep out before it can enter occupied space.

Catalog No	Item	Length
7901-A	3" Base Channel w/ Weep	24'
Available White, Almond, Bronze & Clay		

## 7901-B - 3" Base Channel w/ Chase & Snap

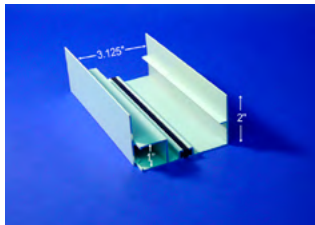

3" base channel designed to anchor wall panels and extruded vertical members to foundation. Inside leg is removable exposing a 1" chase that can be used for wiring. Can also be used as a top cap or a split receiving channel when installing wall sections in between existing posts.

Catalog No	Item	Length
7901-B	3" Base Channel w/ Chase & Snap	24'
Available White, Almond, Bronze & Clay		

## 7906 - 3" Corner Channel - 90°

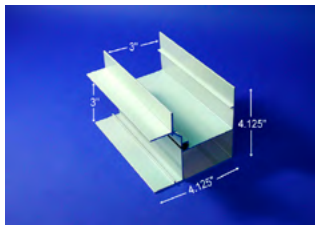

3" corner channel designed for vertical support and used to connect fill panels or wall sections at 90° corners.

Catalog No	Item	Length
7906	3" Corner Channel - 90°	24'
Available White, Almond, Bronze & Clay		

## 7906A - 3" Corner Channel - 45°

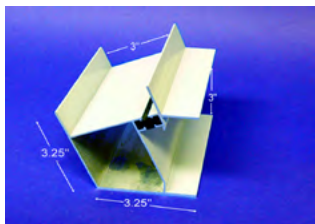

3" corner channel designed for vertical support and used to connect fill panels or wall sections at 45° corners.

Catalog No	Item	Length
7906A	3" Corner Channel - 45°	24'
Available White & Almond		

## 7906B - 3" Corner Channel - 22.5°

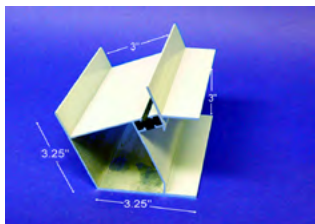

3" corner channel designed for vertical support and used to connect fill panels or wall sections at 22.5° corners.

Catalog No	Item	Length
7906B	3" Corner Channel - 22.5°	24'
Available White & Almond		

### 7902 - 3" Flat Top Cap

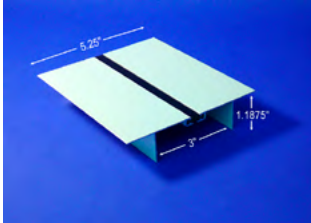

3" top cap designed to cap the wall system and connect the roof to the walls.

Catalog No	Item	Length
7902	3" Flat Top Cap	24'
Available White, Almond, & Bronze		

### 7902A - 3" 3/12 Sloped Top Cap

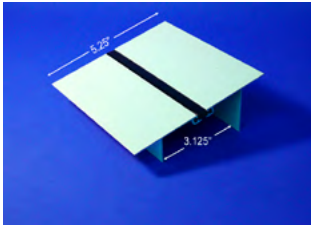

3" top cap designed to cap the wall system and connect the roof to the walls at a 3/12 slope.

Catalog No	Item	Length
7902A	3" 3/12 Sloped Top Cap	24'
Available White, Almond, & Bronze		

### 7912 - 3" Deep Wall Cap Channel

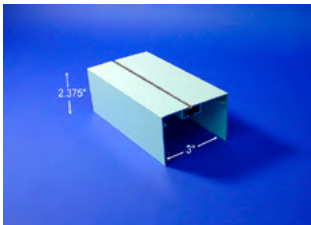

3" deep wall cap designed to cap wall system and connect roof to walls. Typically used when installing walls under an existing roof.

Catalog No	Item	Length
7912	3" Deep Wall Cap Channel	24'
Available White & Almond		

### 7904 - 3" Thermal Receiving Channel

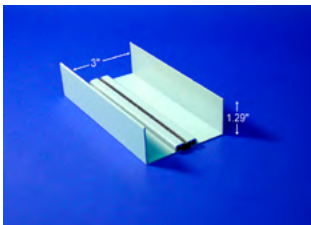

3" receiving channel used as a starter channel at the host structure. 3" panel fits inside.

Catalog No	Item	Length
7904	3" Thermal Receiving Channel	24'
Available White, Almond, Bronze, Ivory & Clay		

### 7904A - 3" Non-Thermal Receiving Channel

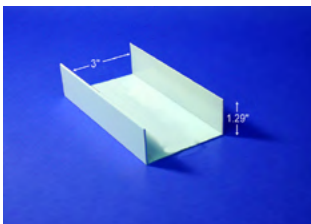

3" non thermal receiving channel can be used as a starter channel at the host structure where panels meet the structure at a 90 degree angle. 3" panel fits inside, available in White only.

Catalog No	Item	Length
7904A	3" Non-Thermal Receiving Channel	24'
Available White only		



## 7909A - 3" Self-mating Column Channel

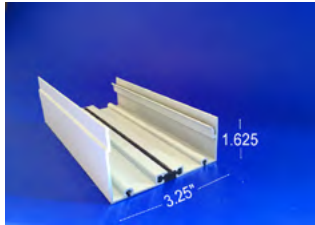

Designed as a vertical support used to join wall sections together. May also be used as a raceway for electrical and will accommodate outlet and switch boxes. (UL Listed)

Catalog No	Item	Length
7909-A	3" Self-mating Column Channel	24'
Available White, Almond, & Bronze		

## 7913 - 3" Male Column Channel

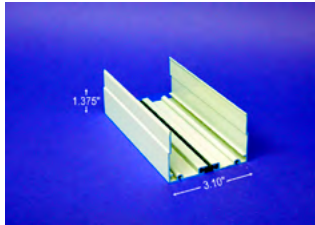

Designed as a vertical support used to join wall sections together. Used in conjunction with #7909 Female Column Channel.

Catalog No	Item	Length
7913	3" Male Column Channel	24'
Available White & Almond		

## 7909 - 3" Female Column Channel

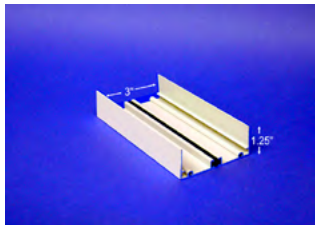

Designed as a vertical support used to join wall sections together. Used in conjunction with #7913 Male Column Channel.

Catalog No	Item	Length
7909	3" Female Column Channel	24'
Available White, Almond, & Bronze		

## 7910 - 3" Panel Adapter

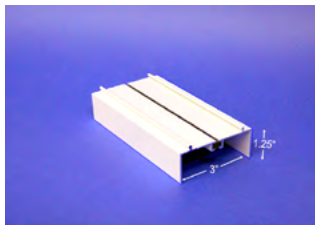

3" panel adapter slides into grooves on male and female column channels and adapts to 3" insulated panels at kneewall and transom locations.

Catalog No	Item	Length
7910	3" Panel Adapter	24'
Available White, Almond, & Bronze		

## 79106 - 3" Thermal Extruded Column Insert

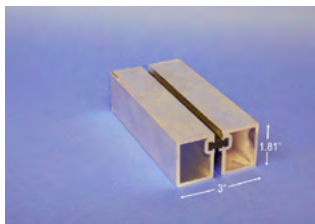

Used as a column connector between wall sections to achieve greater wall heights or as structural support for the installation of doors.

Catalog No	Item	Length
79106	3" Thermal Extruded Column Insert	24'
Available Mill Finish Only		

## 7911 - 2"x5" SGD Framing Tube

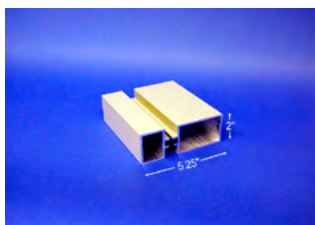

Used to provide structural support for the installation of a sliding glass door.

Catalog No	Item	Length
7911	2"x5" SGD Framing Tube	24'
Available White & Almond		

### 7903 - 3" Thermal H Channel

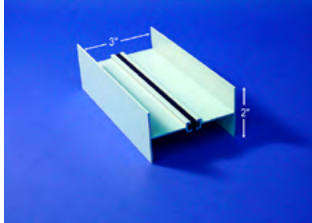

3" H channel can be used as a vertical support on both sides of windows and door. It is also used as a connection between solid wall panels.

Catalog No	Item	Length
7903	3" Thermal H Channel	24'
Available White, Almond, Bronze, Ivory & Clay		

### 7905 - 3" Thermal DRC Channel

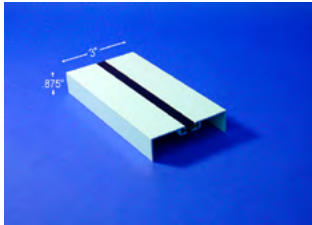

3" D.R.C. channel fits into and fills out the open area of a 3" H channel to provide a finished opening for windows or doors.

Catalog No	Item	Length
7905	3" Thermal DRC Channel	24'
Available White, Almond, Bronze, Ivory & Clay		

### 7508-SQ - 3" Stucco Embossed Aluminum Panel

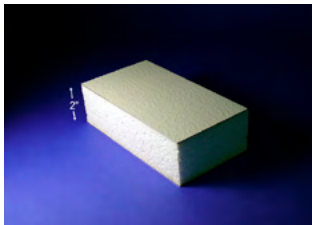

3" thick insulated wall panel. Used in 3" wall systems and is also used to build "end wings" for insulated patio roofs. Aluminum stucco finish.

Catalog No	Width	Length	Item
7508-SQ	4'	8'	3" Stucco Embossed Square Edge Panel
7510-SQ	4'	10'	3" Stucco Embossed Square Edge Panel
Available White, Almond, Bronze, Clay, & Ivory			

### 7508-CDR - 3" Cedar Embossed Aluminum Panel

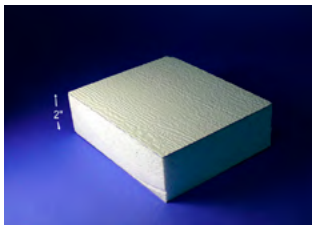

3" thick insulated wall panel. Used in 3" wall systems and is also used to build "end wings" for insulated patio roofs. Aluminum cedar wood grain embossed finish.

Catalog No	Width	Length	Item
7508-CDR	4'	8'	3" Cedar Embossed Square Edge Panel
7510-CDR	4'	10'	3" Cedar Embossed Square Edge Panel
Available White & Almond			

### 7508D - 3" Durashield Panel

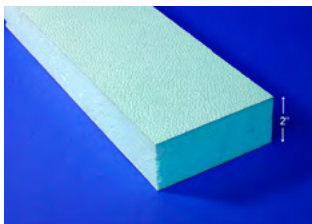

3" thick insulated wall panel. Used in 3" wall systems and is also used to build "end wings" for insulated patio roofs. Laminated with durashield on both sides.

Catalog No	Width	Length	Item
7508D	4'	8'	3" Durashield Square Edge Panel
7510D	4'	10'	3" Durashield Square Edge Panel
Available White, Almond, Bronze, & Clay			

### 7508DA - 3" Durashield/Aluminum Panel

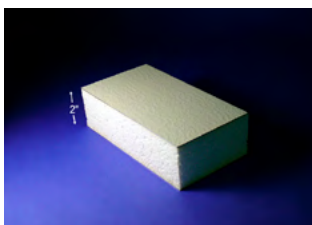

3" thick insulated wall panel. Used in 3" wall systems and is also used to build "end wings" for insulated patio roofs. Panel is laminated with stucco aluminum on one side and durashield on the other.

Catalog No	Width	Length	Item
7508-DA	4'	8'	3" Dura/Alum Square Edge Panel
7510-DA	4'	10'	3" Dura/Alum Square Edge Panel
Available White, Almond, Bronze, & Clay			

# Fasteners & Sealants

## **SERIES 300 - FASTENERS & SEALANTS**

Self-Drilling Tek Screws, Lag Screws, Awning Screws, & Sealants



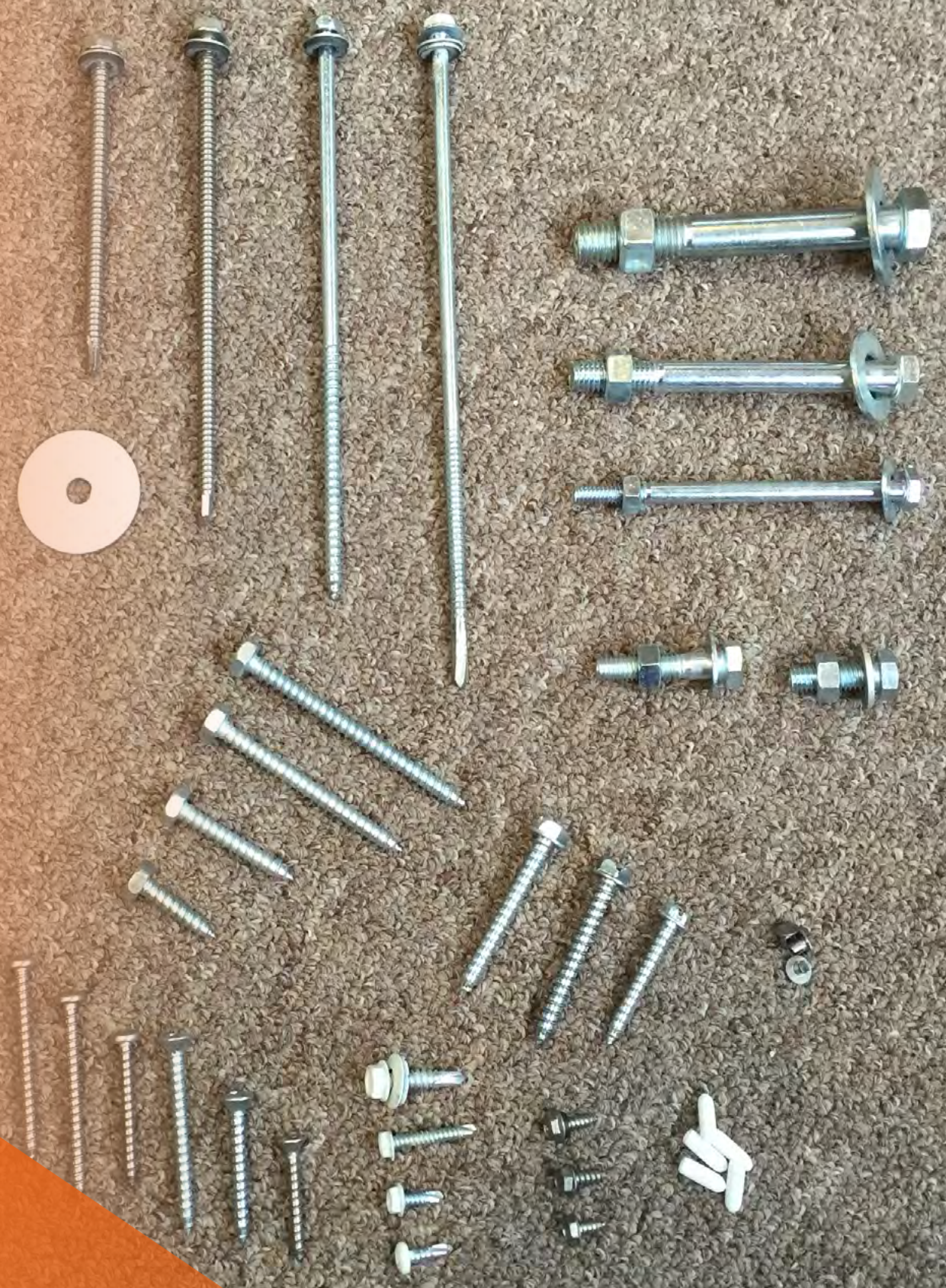

Fasteners & Sealants

**Crest**  
Aluminum



## 300-304 - #14 7/16" Hex Hd Lag Bolts



Screws are threaded the entire length. Length is measured from under head.

Catalog No	Item	Length	Diameter	Pkg Qty
30000	#14 x 1" Lag Bolt 7/16 Hex Hd	1"	.25"	1000
30100	#14 x 1½" Lag Bolt 7/16 Hex Hd	1.50"	.25"	1000
30200	#14 x 2" Lag Bolt 7/16 Hex Hd	2"	.25"	1000
30300	#14 x 2½" Lag Bolt 7/16 Hex Hd	2.50"	.25"	1000
30400	#14 x 3" Lag Bolt 7/16 Hex Hd	3"	.25"	1000

## 301W-304W - #14 7/16" Slotted Hex Hd Washer Lag Bolts



Screws are threaded the entire length. Length is measured from under head.

Catalog No	Item	Length	Diameter	Pkg Qty
301W00	#14 x 1½" Sltd Hex Hd Wshr Lag	1.50"	.25"	1300
302W00	#14 x 2" Sltd Hex Hd Wshr Lag	2"	.25"	1000
303W00	#14 x 2½" Sltd Hex Hd Wshr Lag	2.50"	.25"	1000
304W00	#14 x 3" Sltd Hex Hd Wshr Lag	3"	.25"	1000

## 305 - #6 x 3/8" SS ¼" Hex Hd "A" Screw



Used primarily in the fabrication of aluminum stepdown awnings. Good sharp points with a ¼" hex head.

Catalog No	Item	Length	Diameter	Pkg Qty
30500	#6 x 3/8" SS ¼" Hex Hd "A" Screw	.375"	.14"	5000

## 307 - ¾" x ¼" Zinc Washer

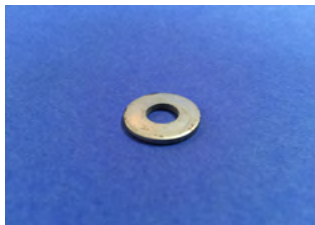

Catalog No	Item	Length	Diameter	Pkg Qty
30700	¾" x ¼" Zinc Washer	.75"	.14"	1000

## 309 - #8 x ½" SS ¼" Hex Hd "A" Screw



410 Stainless awning screw good for fastening into structural components of awning.

Catalog No	Item	Length	Diameter	Pkg Qty
30900	#8 x ½" SS ¼" Hex Hd "A" Screw	.50"	.17"	5000

## 310 - #6 x ½" SS Neo/Wshr ¼" Hex Hd



410 Stainless awning screw with neoprene washer, good for patio awnings.

Catalog No	Item	Length	Diameter	Pkg Qty
31000	#6 x ½" SS Neo/Wshr ¼" Hex Hd	.50"	.14"	5000

**310FLAT - #10 x 1 ¼" Phil Flat Hd 18-8 SS**



Catalog No	Item	Length	Diameter	Pkg Qty
310PHILFLAT	#10 x 1 ¼" Phil Flat Hd 18-8 SS	1.25"	.19"	1000

**310PAN - #10 x 1 ½" Phil Pan Hd 18-8 SS**



Catalog No	Item	Length	Diameter	Pkg Qty
310PHILPAN	#10 x 1 ½" Phil Pan Hd 18-8 SS	1.50"	.19"	1000

**311 - #12 x 1 ½" 5/16" Hex Hd Zinc**



Catalog No	Item	Length	Diameter	Pkg Qty
31100	#12 x 1 ½" 5/16" Hex Hd Zinc	1.50"	.216"	1000

**31102 - #12 x 2" 5/16" Hex Hd Zinc**



Catalog No	Item	Length	Diameter	Pkg Qty
31102	#12 x 2" 5/16" Hex Hd Zinc	2"	.216"	1000

**313 - #12 x 1 ½" Phil Oval Zinc**



Catalog No	Item	Length	Diameter	Pkg Qty
31300	#12 x 1 ½" Phil Oval Zinc	1.50"	.216"	1000

## 314 - #12 x 2" Phil Oval Zinc



Catalog No	Item	Length	Diameter	Pkg Qty
31400	#12 x 2" Phil Oval Zinc	2"	.216"	1000

## 315 - #8 x 1/2" Self-Drilling Hex Hd Tek Screw

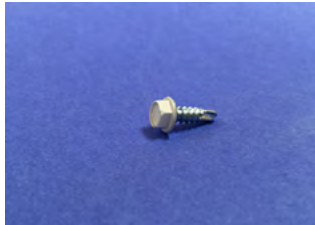

Self-drilling hex head tek screws will drill right into heavy extruded shapes.

Catalog No	Item	Length	Diameter	Pkg Qty
31500	#8 x 1/2" Self-Drilling Hex Hd Tek Screw	.50"	.164"	1000
31500-100	#8 x 1/2" Self-Drilling Hex Hd Tek Screw	.50"	.164"	100
Available in White, Brown, Black, Bronze, & Clay				

## 315A - #8 x 1/2" Self-Drilling Sq Drive Tek Screw



Self-drilling square drive button head tek screws will drill right into heavy extruded shapes.

Catalog No	Item	Length	Diameter	Pkg Qty
315A00	#8 x 1/2" Self-Drilling Sq Drv Tek Screw	.50"	.164"	1000
315A00-100	#8 x 1/2" Self-Drilling Sq Drv Tek Screw	.50"	.164"	100
Available in White, Bronze, Clay, & Almond				

## 323 - #8 x 1" Self-Drilling Sq Drive Tek Screw



Self-drilling square drive button head tek screws will drill right into heavy extruded shapes.

Catalog No	Item	Length	Diameter	Pkg Qty
32300	#8 x 1" Self-Drilling Sq Drv Tek Screw	1"	.164"	1000
Available in White, Black, Brown, Bronze, Clay.				

## 328 - #12 x 1" Self-Drilling Tek w/ Bonded Washer



Catalog No	Item	Length	Diameter	Pkg Qty
32800	#12 x 1" Self-Drilling Tek w/ Bonded Washer	1"	.216"	100

## 324A - #14 Self-Drilling Tek w/ Bonded Washer



Catalog No	Item	Length	Diameter	Pkg Qty
324A00	#14 x 4" Self-Drilling Tek w/ Bonded Washer	4"	.25"	1
32400-6	#14 x 5" Self-Drilling Tek w/ Bonded Washer	5"	.25"	1
32400-8	#14 x 8" Self-Drilling Tek w/ Bonded Washer	8"	.25"	1

**324 - 1/4-20 Bolt, Washer, & Nut Set**



Catalog No	Item	Length	Diameter	Pkg Qty
32400-1	1/4-20 x 1" Bolt, Washer, & Nut Set	1"	.25"	1
32400	1/4-20 x 4" Bolt, Washer, & Nut Set	4"	.25"	1
32400-5	1/4-20 x 5" Bolt, Washer, & Nut Set	5"	.25"	1
32400-7	1/4-20 x 7" Bolt, Washer, & Nut Set	7"	.25"	1

**32400A-2 - 3/8" x 1 1/2" Bolt, Washer, & Nut Set**



Catalog No	Item	Length	Diameter	Pkg Qty
32400A-2	3/8" x 1 1/2" Bolt, Washer, & Nut Set	1.50"	.375"	1

**32400B - 1/2" Bolt, Washer, & Nut Set**



Catalog No	Item	Length	Diameter	Pkg Qty
32400B-1	1/2" x 1" Bolt, Washer, & Nut Set	1"	.50"	1
32400B-4	1/2" x 4" Bolt, Washer, & Nut Set	4"	.50"	1

**325 - 1/4" x 1 1/2" Fender Washer**



Catalog No	Item	Length	Diameter	Pkg Qty
32500	1/4" x 1 1/2" Fender Washer	1.5"	.25"	1

**326 - 3/16" SS Split Rivets**



Stainless 3/16" head x 3/8" shank used to fasten awning tops and sides with 1/2 rivet angle.

Catalog No	Item	Length	Diameter	Pkg Qty
32600	3/16" SS Split Rivets	.375"	.1875"	1000

**119 - White Poly Caps**



White plastic caps cover the exposed tips of screws for a finished look while also protecting your hands. Available in a soft flexible vinyl or hard rigid plastic.

Catalog No	Item	Length	Diameter	Pkg Qty
11900	Poly Caps	.50"	.25"	1000

**135 - Aluminum Bolt Cup & Cap**



A Crest exclusive item! Covers 7/16" bolt head and includes a .093" aluminum washer. Cap is white.

Catalog No	Item	O.D.	i.D.	Pkg Qty
13500	Aluminum Bolt Cup & Cap	1"	.25"	1000



## 308 - OSI SBR 100 VOC Sealant



Formulated for year round use, SBR-100 will extrude consistently and easily from 0°F to 100°F. This unique rubber based product air cures to form a tough elastomeric seal that maintains its bond under most weather conditions. Paintable when fully cured.

Catalog No	Item	Size	Pkg Qty
30800	OSI SBR 100 VOC Sealant	12oz	12
Available in White			

## 308QM - OSI QUADMAX Sealant



OSI QUAD® MAX siding & window sealant delivers the toughness that really makes a job last. QUAD® MAX is the next generation of siding and window sealants, providing maximum durability and superior application performance for use in any condition.

Catalog No	Item	Size	Pcs/Ctn
308QM00	OSI QUADMAX Sealant	9.5 oz	12
Available in White			

## 317A - Dow Corning CWS



This unique medium-modulus 100% silicone joint sealant, weather-resistant formulation is ideal to withstand adverse conditions, including moisture, movement, sheer and deflection, in common installations. It is easily gunnable in all weather conditions from -20 to 120°F (-29 to 49°C).

Catalog No	Item	Size	Pcs/Ctn
317A00	Dow Corning CWS 10.3 oz Cartridge	10.3 oz	12
Available in White, Bronze, & Almond			

## 319 - Chilton Heavy Duty Caulking Gun



The last caulking gun you will ever buy. Heavy duty ratchet style applicator. High quality metal construction holds 10.5oz cartridges.

Catalog No	Item	Length	Diameter	Pkg Qty
31900	Chilton Heavy Duty Caulking Gun	-	-	1

## 375 - 4" Peel & Seal® PowerBond™ 250 Tape - 50' Roll



Peel & Seal® PowerBond™ White 250 is thinner and more aggressive than normal Peel & Seal®, making it easier to install. It is specifically designed to tape seams on insulated aluminum panels or can be used as a flashing material for roof and gutter repair, window flashing and as a general-purpose waterproofing product.

Catalog No	Item	Length	Colors
37500	4" Peel n Seal PowerBond 250' Roll	50'	White
<i>Almond available in standard Peel &amp; Seal Tape</i>			

## 430 - 12oz Spray Paint Touch Up



Patented, self-stick, rolled roofing perfect for low slope applications. Your answer for those hard to seal areas. Firmly adheres to clean, dry surfaces.

Catalog No	Item	Size	Colors
43000	12oz Krylon Spray Paint	12oz	White, Black, Brown
43000-CREST	12oz Custom Spray Paint	12oz	White, Brown, Bronze, Colonial White, Clay

"No Voicemail - Just Real People"

[www.crestaluminum.com](http://www.crestaluminum.com)



# Sovereign Aluminum Railing

**SERIES 600 - Sovereign Aluminum Railing**  
Decorative Handrail & Accessories



Sovereign Railing

**Crest**  
Aluminum

Photo courtesy of Home Metal Supply - Ohio

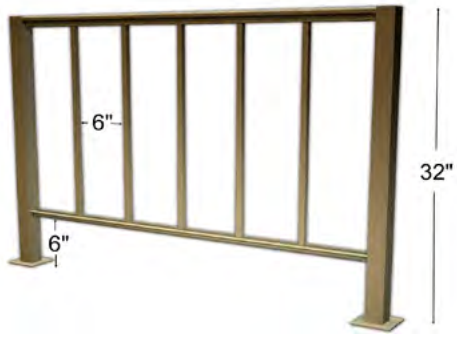

<b>601 Series Sovereign Railing Kits</b>				
30" High Sovereign Rail, 24" Pickets - 6" o.c.				
For 30" high installations. Pickets are 24" long, spaced 6" on center. Bottom rail is 6" off ground. Extended center picket and flange included in all kits 4' and longer.				
Available in White, Brown, Black, & Clay			All fittings are die cast aluminum - NO plastic used!	
Item No	Size	Description	Extended Picket	UPS?
60102	2'	2' Sovereign Rail Kit - 30" High	No	Yes
60103	3'	3' Sovereign Rail Kit - 30" High	No	Yes
60104	4'	4' Sovereign Rail Kit - 30" High	Yes	Yes
60105	5'	5' Sovereign Rail Kit - 30" High	Yes	Yes
60106	6'	6' Sovereign Rail Kit - 30" High	Yes	Yes
60107	7'	7' Sovereign Rail Kit - 30" High	Yes	Yes
60108	8'	8' Sovereign Rail Kit - 30" High	Yes	No
<p><i>Sovereign railing kits are for use as decorative railing only, and should not be installed where failure could result in personal injury. Consult local building codes for proper application.</i></p>				

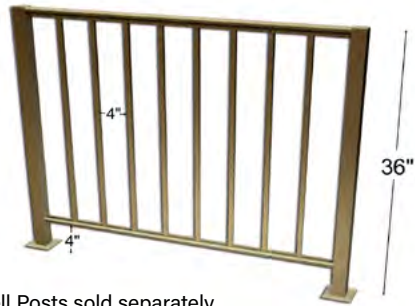
<b>602 Series Sovereign Railing Kits</b>				
36" High Sovereign Rail, 36" Pickets - 4" o.c.				
Used where 4" maximum openings and 36" height are required by code. Pickets are 32" long, spaced 4" on center. Extended center picket and flange included on all kits 4' and longer.				
Available in White, Brown, Black, & Clay			All fittings are die cast aluminum - NO plastic used!	
Item No	Size	Description	Extended Picket	UPS?
60202	2'	2' Sovereign Rail Kit - 36" High	No	Yes
60203	3'	3' Sovereign Rail Kit - 36" High	No	Yes
60204	4'	4' Sovereign Rail Kit - 36" High	Yes	Yes
60205	5'	5' Sovereign Rail Kit - 36" High	Yes	Yes
60206	6'	6' Sovereign Rail Kit - 36" High	Yes	Yes
60207	7'	7' Sovereign Rail Kit - 36" High	Yes	No
60208	8'	8' Sovereign Rail Kit - 36" High	Yes	No
<p><i>Sovereign railing kits are for use as decorative railing only, and should not be installed where failure could result in personal injury. Consult local building codes for proper application.</i></p>				

\*Newell Posts sold separately

### 60100 - Sovereign Rail Hardware Kit



Included in all rail kits, handy to have extras for spare parts. Contains 4 die-cast powder coated aluminum end brackets, an extended spindle shoe, and color matched fasteners.

Catalog No	Item	Length	Pcs / Ctn
60100	Sovereign Rail Hardware Kit	-	1
Available White, Brown, Black, & Clay			

### 60200-60236 - 32"/37" High Sovereign Rail Newell Post

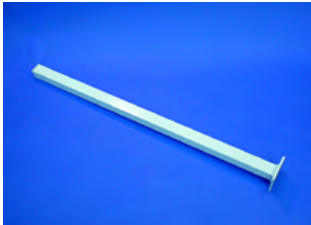

Heavy 1 1/2" extruded aluminum newel posts have welded base flanges. 32" post is used with 601 series railing.

Catalog No	Item	Length	Pcs / Ctn
60200	32" High Sovereign Rail Newell Post	32"	15
60236	37" High Sovereign Rail Newell Post	37"	15
Available White, Brown, Black, & Clay			

### 603 - 1/2" Extended Picket Floor Flange



Cast Aluminum flange receives the 1/2" extended picket on all rail kits longer than 4'.

Catalog No	Item	Length	Pcs / Ctn
60300	1/2" Extended Picket Floor Flange	-	1
Available White, Brown, Black, & Clay			

### 618 - Sovereign Rail End Bracket



Die cast aluminum connector included in all rail kits. This is used to join rail to newel post or wall. Powder coat finished in black, brown, clay, & white.

Catalog No	Item	Length	Pcs / Ctn
61800	Sovereign Rail End Bracket	-	1
Available White, Brown, Black, & Clay			

### 604B - Sovereign Rail 2pc Bottom Swivel



Die cast aluminum 2 pc fittings adjust to any angle. Fits into bottom of rail and adjusts automatically and eliminates cutting. Powder coat finished in black, brown, clay, or white.

Catalog No	Item	Length	Pcs / Ctn
60400B	Sovereign Rail 2pc Bottom Swivel	-	1
Available White, Brown, Black, & Clay			

### 604T - Sovereign Rail 2pc Top Swivel



Die cast aluminum 2 pc fittings adjust to any angle. Fits into top of rail and adjusts automatically and eliminates cutting. Powder coat finished in black, brown, clay, or white.

Catalog No	Item	Length	Pcs / Ctn
60400T	Sovereign Rail 2pc Top Swivel	-	1
Available White, Brown, Black, & Clay			

## 606 - Newell Post Cross Over Cap



Cast aluminum fitting for installing newel post in place of extended center picket without cutting top rail. Also used to extend rail past newel post.

Catalog No	Item	Length	Pcs / Ctn
60600	Newell Post Cross Over Cap Mill Finish Only	-	1

## 607 - Rail End Knob

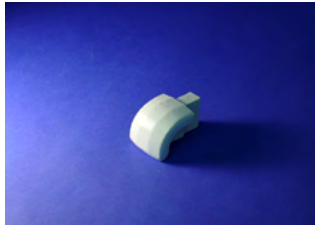

Cast aluminum knob finishes off ends of hand rail when not terminating into a post or wall.

Catalog No	Item	Length	Pcs / Ctn
60700	Rail End Knob Available White & Black	-	1

## 608 - Sovereign Rail - Top Hand Rail



Top hand rail only. Used to create a handrail along a wall, often used with our #609 Handrail Wall Bracket.

Catalog No	Item	Length	Pcs / Ctn
60800	Sovereign Rail Top Hand Rail Available White, Brown, Black, & Clay	3'-12"	1

## 609 - Handrail Offset Wall Bracket



Cast aluminum bracket used for hand railing installations along a wall.

Catalog No	Item	Length	Pcs / Ctn
60900	Handrail Offset Wall Bracket Available White & Black	-	1

## 610 - Sovereign Rail Gate Kit



Gate Kit: Hinges, Corner Gussets, & Tubes

Allows you to create a swing gate using Sovereign Handrail. Width of the gate is determined by the length of railing used.

Catalog No	Length	Pcs / Ctn
61000	Gate Kit	1

Available White & Black

## 611 - 1" Column Adapter Fitting

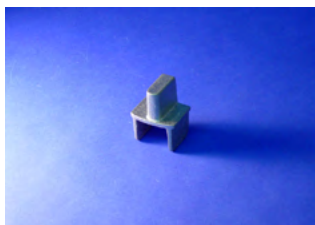

Cast aluminum. Used to connect Sovereign railing to 1" columns.

Catalog No	Item	Length	Pcs / Ctn
61100	1" Column Adapter Fitting Mill Finish Only	-	1

## 61200,61236 - 1½" x 30",36" Railing Wall Plate



Heavy 1 1/2" extruded aluminum plate for mounting rail to brick or stone.

Catalog No	Item	Length	Pcs / Ctn
61200	1½" x 30" Railing Wall Plate	30"	1
61236	1½" x 36" Railing Wall Plate	36"	1

Available White, Brown, Black, & Clay

## 613 - Lambs Tongue



Cast aluminum lamb's tongue used to finish off end of railing at newel post.

Catalog No	Item	Length	Pcs / Ctn
61300	Lambs Tongue	-	1

Available White & Black

## 614 - Rail End Step Scroll



A heavy duty "S" scroll used to finish of the end of a section of handrail at the bottom of the steps.

Catalog No	Item	Length	Pcs / Ctn
61400	Rail End Step Scroll	-	1

Available White, Brown, & Black

## 626 - 1½" Newell Post Cap

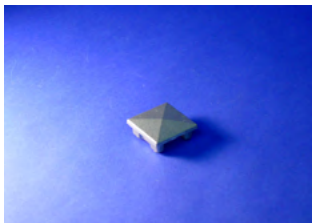

Die cast aluminum newel post cap for making custom length newel posts.

Catalog No	Item	Length	Pcs / Ctn
62600	1½" Newell Post Cap	1.5" x 1.5"	1

Available Mill Finish

## 627 - Sovereign Rail Heart Scrolls



Decorative "heart" shaped scroll. Standard is a 2 piece scroll that is fastened to either side of the railing pickets, and the deluxe is pre-assembled and uses clips to fasten to the pickets of the 601 series hand rail.

Catalog No	Item	Length	Pcs / Ctn
62700	Sovereign 601 Rail Deluxe Heart Scroll	-	1
62701	Sovereign 601 Rail Standard Heart Scroll	-	1
62702	Sovereign 602 Rail Standard Heart Scroll	-	1

Available White, Brown, Black, & Clay

## 628 - Sovereign Rail Diamond Scrolls



These decorative "diamond" shaped 2 pc scroll sets gets fastened to either side of the pickets of the 601 or 602 series rail.

Catalog No	Item	Length	Pcs / Ctn
62800	Sovereign Rail Standard Diamond Scroll	-	1
62802	Sovereign Rail 602 Series Diamond Scroll	-	1

Available White, Brown, & Black



# Comfort-Tite Storm & Screen Doors

**SERIES 800 - Comfort-Tite Storm & Screen Doors**  
Quality Aluminum Storm & Screen Doors





Storm / Screen Doors

**Crest**  
Aluminum



## 8500 Hi-Lite Storm/Screen Door

Standard widths of 30", 32", 36"

Hi-Lite Storm Door features a full 1 1/4" thick aluminum frame with an 18" kick plate and comes standard with both tempered glass & screen inserts. The Hi-Lite door has a shorter lower insert, balanced out by a taller upper insert. All doors come standard with an adjustable sweep, black push button handle set, and heavy duty hydraulic closer with safety strap. Additional hardware options are available.

Available White, Black, Brown, Bronze, Clay, & Wicker Beige

Item No	Size	Description
850030	30" x 80"	30" x 80" Hi-Lite Storm Door
850030-SCR	30" x 80"	30" x 80" Hi-Lite Screen Door
850032	32" x 80"	32" x 80" Hi-Lite Storm Door
850032-SCR	32" x 80"	32" x 80" Hi-Lite Screen Door
850036	36" x 80"	36" x 80" Hi-Lite Storm Door
850036-SCR	36" x 80"	36" x 80" Hi-Lite Screen Door
8500-	-	Custom Size Hi-Lite Door



## 8501 One-Lite Storm/Screen Door

Standard widths of 30", 32", 36"

One-Lite Storm Door features a full 1 1/4" thick aluminum frame with a 10" kick plate and comes standard with both tempered glass & screen inserts. The One-Lite door has a single insert, providing excellent visibility and ventilation. All doors come standard with an adjustable sweep, black push button handle set, and heavy duty hydraulic closer with safety strap. Additional hardware options are available.

Available White, Black, Brown, Bronze, Clay, & Wicker Beige

Item No	Size	Description
850130	30" x 80"	30" x 80" One-Lite Storm Door
850130-SCR	30" x 80"	30" x 80" One-Lite Screen Door
850132	32" x 80"	32" x 80" One-Lite Storm Door
850132-SCR	32" x 80"	32" x 80" One-Lite Screen Door
850136	36" x 80"	36" x 80" One-Lite Storm Door
850136-SCR	36" x 80"	36" x 80" One-Lite Screen Door
8501-	-	Custom Size One-Lite Door



<b>8502 Equi-Lite Storm/Screen Door</b>		
Standard widths of 30", 32", 36"		
Equi-Lite Storm Door features a full 1¼" thick aluminum frame with an 18" kick plate and comes standard with both tempered glass & screen inserts. The Equi-Lite door has two equal sized inserts for a balanced, symmetrical look. All doors come standard with an adjustable sweep, black push button handle set, and heavy duty hydraulic closer with safety strap. Additional hardware options are available.		
Available White, Black, Brown, Bronze, Clay, & Wicker Beige		
Item No	Size	Description
850230	30" x 80"	30" x 80" Equi-Lite Storm Door
850230-SCR	30" x 80"	30" x 80" Equi-Lite Screen Door
850232	32" x 80"	32" x 80" Equi-Lite Storm Door
850232-SCR	32" x 80"	32" x 80" Equi-Lite Screen Door
850236	36" x 80"	36" x 80" Equi-Lite Storm Door
850236-SCR	36" x 80"	36" x 80" Equi-Lite Screen Door
8502-	-	Custom Size Equi-Lite Door



<b>8503 Deluxe Hi-Lite Storm/Screen Door</b>		
Standard widths of 30", 32", 36"		
Deluxe Hi-Lite Storm Door features a full 1¼" thick aluminum frame with a 6" kick plate and comes standard with both tempered glass & screen inserts. Deluxe Hi-Lite is similar to the Hi-Lite door, but has a larger lower insert with a shorter kick plate. All doors come standard with an adjustable sweep, black push button handle set, and heavy duty hydraulic closer with safety strap. Additional hardware options are available.		
Available White, Black, Brown, Bronze, Clay, & Wicker Beige		
Item No	Size	Description
850330	30" x 80"	30" x 80" Dlx Hi-Lite Storm Door
850330-SCR	30" x 80"	30" x 80" Dlx Hi-Lite Screen Door
850332	32" x 80"	32" x 80" Dlx Hi-Lite Storm Door
850332-SCR	32" x 80"	32" x 80" Dlx Hi-Lite Screen Door
850336	36" x 80"	36" x 80" Dlx Hi-Lite Storm Door
850336-SCR	36" x 80"	36" x 80" Dlx Hi-Lite Screen Door
8503-	-	Custom Size Dlx Hi-Lite Door





## 85A553 - 20'-0" 1¼" Door Stile

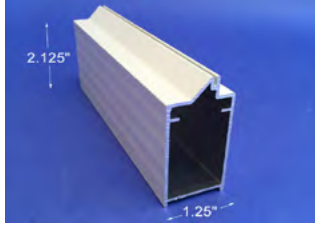

Catalog No	Item	Length	Pcs / Ctn
85A553	20'-0" 1¼" Door Stile	20'	8

Available White, Black, Brown, Bronze, Clay, & Wicker Beige

## 85A551 - 10'-6" 1¼" Door Center Rail

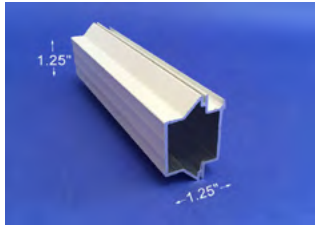

Catalog No	Item	Length	Pcs / Ctn
85A551	10'-6" 1¼" Door Center Rail	10'-6"	12

Available White, Black, Brown, Bronze, Clay, & Wicker Beige

## 85A119 - 10'-6" 1" x 5/16" Screen Frame

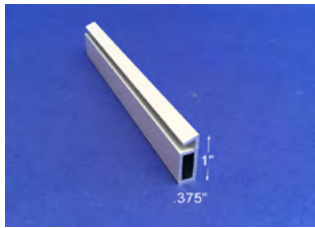

Catalog No	Item	Length	Pcs / Ctn
85A119	10'-6" 1" x 5/16" Screen Frame	10'-6"	25

Available White, Black, Brown, Bronze, Clay, & Wicker Beige

## 85A365 - 10'-6" 5/8" x 5/16" Sash Frame

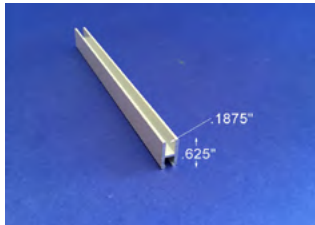

Catalog No	Item	Length	Pcs / Ctn
85A365	10'-6" 5/8" x 5/16" Sash Frame	10'-6"	50

Available White, Brown, Bronze, Clay, & Wicker Beige

## 85A531 - 10'-6" 5/8" x 5/16" Sash Frame w/ weather-strip



Catalog No	Item	Length	Pcs / Ctn
85A531	10'-6" 5/8" x 5/16" Sash Frame w/ wthrstrp	10'-6"	50

Available White, Brown, Bronze, Clay, & Wicker Beige

## 85A501 - 10'-0" Hinge Leaf



Catalog No	Item	Length	Pcs / Ctn
85A501	10'-0" Hinge Leaf	10'	30

Available White, Brown, Bronze, Clay, & Wicker Beige

**85A510 - 12'-8" 1¼" Z Bar Header**

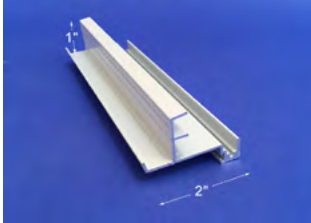

Catalog No	Item	Length	Pcs / Ctn
85A510	12'-8" 1¼" Z Bar Header	12'-8"	14
Available White, Black, Brown, Bronze, Clay, & Wicker Beige			

**85A511 - 12'-8" 1¼" Z Bar**

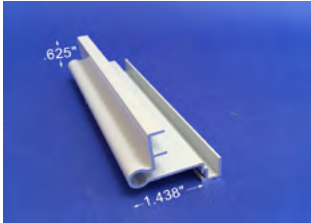

Catalog No	Item	Length	Pcs / Ctn
85A511	12'-8" 1¼" Z Bar	12'-8"	14
Available White, Black, Brown, Bronze, Clay, & Wicker Beige			

**85A1319 - 12'-0" 1¼" Door Expander**

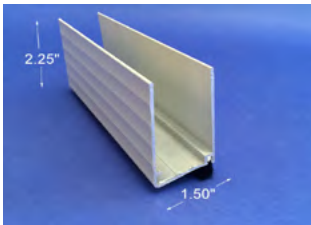

Catalog No	Item	Length	Pcs / Ctn
85A1319	12'-0" 1¼" Door Expander	12'	12
Available White, Black, Brown, Bronze, Clay, & Wicker Beige			

**8000HQB - Z Bar Hinge Side Only / 4 Oilite Hinges**

Catalog No	Item	Length	Pcs / Ctn
8000HQB	Z Bar Hinge Side Only	81", 85", 97"	30
Available White, Brown, Bronze, Clay, & Wicker Beige			

**8000ZBS - Z Bar Set Complete / Pre-punched**

Catalog No	Item	Length	Pcs / Ctn
8000ZBS	Z Bar Set Complete / Pre-punched	81", 85", 97"	10
Available White, Brown, Bronze, Clay, & Wicker Beige			

**8000ZBH - Assembled Leaf Hinge**



Catalog No	Item	Length	Pcs / Ctn
8000ZBH	Assembled Leaf Hinge	4"	50
Available White, Brown, Bronze, Clay, & Wicker Beige			

## 85B502 - Bronze Oilite® Hinge Bushing



Catalog No	Item	Size	Pcs / Ctn
85B502	Bronze Oilite® Hinge Bushing	1/4" x 7/16"	100

## 85B424 - Stainless Hinge Spring



Catalog No	Item	Length	Pcs / Ctn
85B424	Stainless Hinge Spring	3.5"	1000

## 85B423 - Stainless Hinge Solid Rivet



Catalog No	Item	Length	Pcs / Ctn
85B423	Stainless Hinge Solid Rivet	.625"	1000

## 85A500 - 4" Hinge Leaf Only

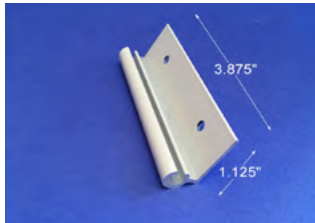

Catalog No	Item	Length	Pcs / Ctn
85A500	4" Hinge Leaf Only	4"	1

Available White, Brown, Bronze, Clay, & Wicker Beige

## 85B477 - 1 1/4" Steel Corner Gusset



Catalog No	Item	Length	Pcs / Ctn
85B477	1 1/4" Steel Corner Gusset	3.75"x3.75"	1

## 800520-BL - .187"x.150" Z Bar Weather Strip



Catalog No	Item	Length	Pcs / Ctn
800520-BL	.187"x.150" Z Bar Weather Strip	1000'	1 Roll

Available in Black only

### 80A1320 - Black Wool Pile for Door Expander



Catalog No	Item	Length	Pcs / Ctn
80A1320	Black Wool Pile for Door Expander Available in Black	3000'	1 Roll

### 85A359 - SD 8-32 x 1/2" Aluminum Rivnut

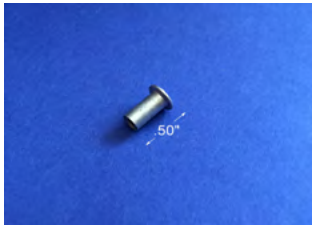

Catalog No	Item	Length	Pcs / Ctn
85A359	SD 8-32 x 1/2" Aluminum Rivnut	8-32x1/2"	1000

### 85B302 - Clear Polycarbonate Sash Clip

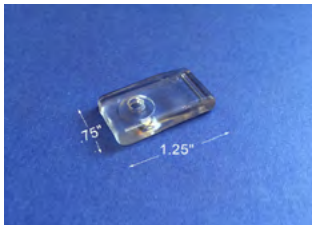

Catalog No	Item	Length	Pcs / Ctn
85B302	Clear Polycarbonate Sash Clip	.75" x 1.25"	100

### 85B170 - A 119 Zinc Screen Frame Corner Insert



Catalog No	Item	Length	Pcs / Ctn
85B170	A 119 Zinc Screen Frame Corner Insert	2.25"x2.25"	450

### 85B336 - Nylon Sash Frame Corner Insert



Catalog No	Item	Length	Pcs / Ctn
85B336	Nylon Sash Frame Corner Insert Available White only	1" x 1"	1000



**88RG003 - Standard Push Button Handle**

Catalog No	Item	Finish
88RG003-444-2	Standard Push Button Handle	Black

**8800KLS - Keyed Push Button Handle**

Catalog No	Item	Finish
8800KLS	Keyed Push Button Handle	Black

**850012PB - Keyed Lever Handle - Polished Brass**

Catalog No	Item	Finish
850012PB	Keyed Lever Handle	Polished Brass

**INSWING - Inswing Hardware Kit & Closer Bracket**

Catalog No	Item	Finish
INSWING	Inswing Hardware Kit & Bracket	Black







Service is our most important product

## The new leader in aluminum building products

Your complete source for aluminum building products. If it is aluminum and you can use it, we will carry it for you.

Crest Aluminum Products Company Inc. has been a family-owned, customer oriented manufacturer of aluminum building products for over 40 years. Throughout those 40 years we have been committed to providing our customers with the highest level of service and support while continuing to offer affordable quality aluminum building products. When you call, you will get to talk to a real person. "No Voicemail, Just Real People" is more than just a slogan, its the way we do business.

8287 Tyler Blvd. Mentor, Ohio 44060 USA



## Terms and Conditions of Sale

### Terms of Payment:

- 1.1 Net 30 Day Terms are extended to all accounts approved by our Credit Department in Mentor, OH.
- 1.2 A 1% discount may be taken if payment is postmarked within 10 days of the original invoice date. Certain restrictions apply.
- 1.3 Discounts are not allowed on accounts that are past terms or on accounts considered C.O.D. or C.I.A. status.
- 1.4 A 1% discount may be taken on any Coil sales if payment is postmarked within 10 days of the original invoice date.
- 1.5 A service charge of 1.50% per month may be applied to any overdue balances.

### Limit of Liability - Material Selection:

- 2.1 The limit of liability shall not exceed the total invoice price.
- 2.2 Crest Aluminum Products, Inc accepts NO responsibility for the selection and/or application of materials.

### When Ordering:

- 3.1 Please provide your complete Company Name including the city and state.
- 3.2 To avoid any errors and delays, please use our Catalog Numbers and Color Codes.
- 3.3 Please feel free to provide any special instructions or requests in regards to shipping or handling your order.

### Prices:

- 4.1 All prices are FOB our warehouse in Mentor, OH and are subject to change without notice.

### Standard Packaging:

- 5.1 This catalog shows items in standard stock packaging quantities. Special lengths and/or quantities are available on most products. Please allow additional time for custom orders. Additional fees may apply.
- 5.2 Packaging quantities and standard lengths are subject to change.

### Acceptance of Orders:

- 6.1 All orders are considered to be accepted by Crest Aluminum Products, Inc either by acknowledgment or by shipment of the order.

### Returns:

- 7.1 No material will be accepted for return without express written authorization from Crest Aluminum Products, Inc.
- 7.2 Any material returned must be in good salable condition and in its original package.

### Restocking Charge:

- 8.1 A 20% restocking charge may be assessed on all materials returned for credit. This includes, but is not limited to, any material ordered in error, duplicated orders, or return of excess stock.

### Freight Claims:

- 9.1 When a common carrier picks up a shipment and signs the Bill Of Lading, this verifies that the shipment is complete and in good condition. At this point title for the material passes to the carrier. Claims for damaged materials caused by improper handling of your material by the freight line should follow this procedure:

- 1) Note the damage or shortage on the Bill of Lading at the time the material is received by you.
- 2) Call the local office of the freight line for inspection immediately.
- 3) If any concealed damage or loss is discovered, notify the freight line at once and request an inspection.
- 4) File your claim with the delivering truck line, attaching a copy of your Bill of Lading, a copy of your invoice, and your inspection report.
- 5) Please notify your Crest representative, or the Mentor, OH office, of your problem and we will help you in any way possible to expedite your claim.





**NATUREWOOD**  
*Pergola*

Whether you're gardening, swimming, relaxing, or entertaining, the cool shade of your new Naturewood Pergola system will make

it much more enjoyable. In addition to comfort, the Naturewood Pergola patio cover is totally weather resistant with unsurpassed durability.

A traditional wood pergola will crack, warp, split, and require re-staining or resealing. With state of the art computer precision controlled machinery and the Duracoat XT-10 finishing systems, the Naturewood Pergola system will preserve its beauty for years, without the necessary maintenance required in other pergola systems.



### Residential

For over 40 years, Crest Aluminum has endeavored to become the leading supplier of residential aluminum building products. From Stepdown Awning Components to Patio Covers & Carports, Storm & Screen Doors, Screen Rooms and Sun Rooms, Crest Aluminum continues to improve its reputation while staying dedicated to producing affordable quality products.

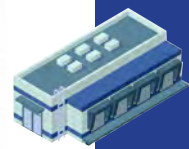

### Commercial

Crest Aluminum supplies the commercial industry with innovative building products backed by our exceptional customer service. Aluminum coil in a variety of colors, widths & thicknesses, loading dock covers & overhead canopies, walkway covers, channel letter coil, and leveled cut-to-length sheet for the sign and truck trailer industries.



### Marine

Crest Aluminum offers a complete line of in stock aluminum toe rail and t-track for the marine industry.



When quality matters, choose



If its aluminum and you can use it, we will carry it for you.

8287 Tyler Blvd Mentor, OH 44060 USA  
Phone: 800-255-1588 Fax: 800-255-1583  
info@crestaluminum.com

